

# JVC

**CD RECEIVER**  
CD-RECEIVER  
RECEPTEUR CD  
CD-RECEIVER

## KD-S891R

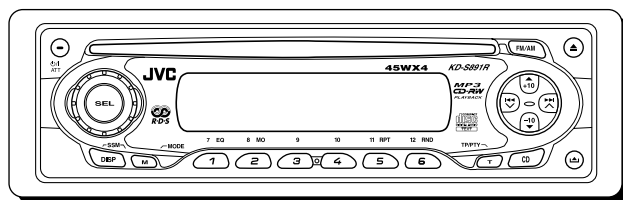
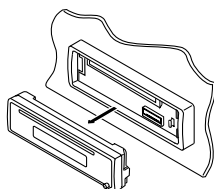

**MP3**  
**CD-RW**  
PLAYBACK

For installation and connections, refer to the separate manual.

Für den Einbau und die Anschlüsse siehe das eigenständige Handbuch.

Pour l'installation et les raccordements, se référer au manuel séparé.

Bijzonderheden over de installatie en aansluiting van het apparaat vindt u in de desbetreffende handleiding.

# INSTRUCTIONS

**BEDIENUNGSANLEITUNG**  
**MANUEL D'INSTRUCTIONS**  
**GEbruIKSAANWIJZING**

GET0136-001A  
[E/EX]

ENGLISH

DEUTSCH

FRANÇAIS

NETERLANDS

## Position And Reproduction Of Labels

Bottom panel of the main unit

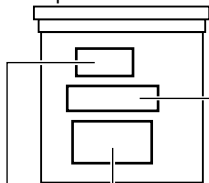

Name/Rating plate

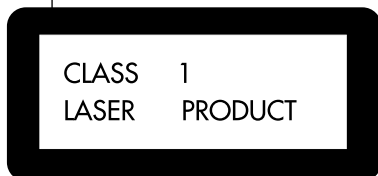

<p><b>CAUTION:</b> Invisible laser radiation when open and interlock failed or defeated. AVOID DIRECT EXPOSURE TO BEAM. (e)</p>	<p><b>ADVARSEL:</b> Usynlig laserstråling ved åbning, når sikkerhedsafbrydere er ude af funktion. Undgåudsættelse for stråling. (d)</p>	<p><b>VARNING:</b> Osynlig laserstråling när denna del är öppnad och spärren är urkopplad. Betrakta ej strålen. (s)</p>	<p><b>VARO:</b> Avattaessa ja suojalukitus ohitettaessa olet alttiina näkymättömälle lasersäteilylle. Älä katso säteeseen. (f)</p>
---	---	---	--

## IMPORTANT FOR LASER PRODUCTS

### Precautions:

1. **CLASS 1 LASER PRODUCT**
2. **CAUTION:** Invisible laser radiation when open and interlock failed or defeated. Avoid direct exposure to beam.
3. **CAUTION:** Do not open the top cover. There are no user-serviceable parts inside. Leave all servicing to qualified service personnel.
4. **CAUTION:** This CD player uses invisible laser radiation and is equipped with safety switches to prevent radiation emission when unloading CDs. It is dangerous to defeat the safety switches.
5. **CAUTION:** Use of controls, adjustments or performance of procedures other than those specified herein may result in hazardous radiation exposure.

### Caution:

This product contains a laser component of higher laser class than Class 1.

## How to reset your unit

While holding SEL (select), press **⏻/ATT** (standby/on/attenuator) for more than 2 seconds. This will reset the built-in microcomputer.

### Notes:

- Your preset adjustments—such as preset channels or sound adjustments—will also be erased.
- If a disc is in the unit, it will eject when you reset the unit. Be careful not to drop the disc.

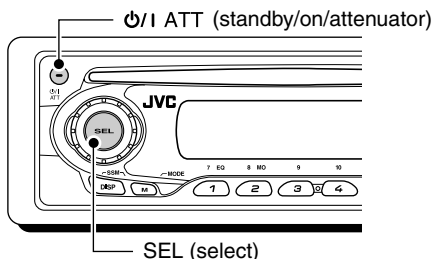

## How to use the M (MODE) button

If you press M (MODE), the unit goes into functions mode, then number buttons and **▲/▼** buttons work as different function buttons.

Ex.: When number button 2 works as MO (monaural) button.

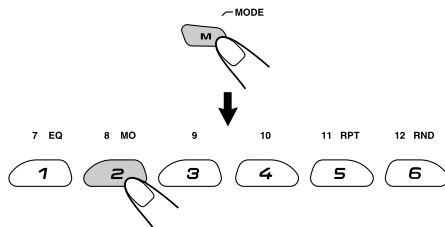

To use these buttons for original functions again after pressing M (MODE), wait for 5 seconds without pressing any of these buttons until the functions mode is cleared.

- Pressing M (MODE) again also clears the functions mode.

Thank you for purchasing a JVC product. Please read all instructions carefully before operation, to ensure your complete understanding and to obtain the best possible performance from the unit.

# CONTENTS

How to reset your unit .....	2	<b>MP3 INTRODUCTION .....</b>	<b>21</b>
How to use the M (MODE) button .....	2	What is MP3? .....	21
<b>LOCATION OF THE BUTTONS .....</b>	<b>4</b>	How are MP3 files recorded and played back? .....	21
Control panel .....	4	<b>MP3 OPERATIONS .....</b>	<b>23</b>
<b>BASIC OPERATIONS .....</b>	<b>5</b>	Playing an MP3 disc .....	23
Turning on the power .....	5	Locating a file or particular portion on an MP3 disc .....	25
Setting the clock .....	6	Selecting MP3 playback modes .....	27
<b>RADIO OPERATIONS .....</b>	<b>7</b>	<b>SOUND ADJUSTMENTS .....</b>	<b>28</b>
Listening to the radio .....	7	Selecting preset sound modes (C-EQ: custom equalizer) .....	28
Storing stations in memory .....	8	Adjusting the sound .....	29
Tuning in to a preset station .....	9	<b>OTHER MAIN FUNCTIONS .....</b>	<b>30</b>
<b>RDS OPERATIONS .....</b>	<b>10</b>	Changing the general settings (PSM) .....	30
What you can do with RDS .....	10	Detaching the control panel .....	33
Other convenient RDS functions and adjustments .....	14	<b>USING THE REMOTE CONTROLLER .....</b>	<b>34</b>
<b>CD OPERATIONS .....</b>	<b>17</b>	Location of the buttons .....	35
Playing a CD .....	17	<b>TROUBLESHOOTING .....</b>	<b>36</b>
Locating a track or a particular portion on a CD .....	18	<b>MAINTENANCE .....</b>	<b>38</b>
Selecting CD playback modes .....	19	Handling discs .....	38
Playing a CD Text .....	20	<b>SPECIFICATIONS .....</b>	<b>39</b>
Prohibiting disc ejection .....	20		

**Note:**

For security reasons, a numbered ID card is provided with this unit, and the same ID number is imprinted on the unit's chassis. Keep the card in a safe place, as it will help the authorities to identify your unit if stolen.

**BEFORE USE**

**\*For safety....**

- Do not raise the volume level too much, as this will block outside sounds, making driving dangerous.
- Stop the car before performing any complicated operations.

**\*Temperature inside the car....**

If you have parked the car for a long time in hot or cold weather; wait until the temperature in the car becomes normal before operating the unit.



# LOCATION OF THE BUTTONS

ENGLISH

## Control panel

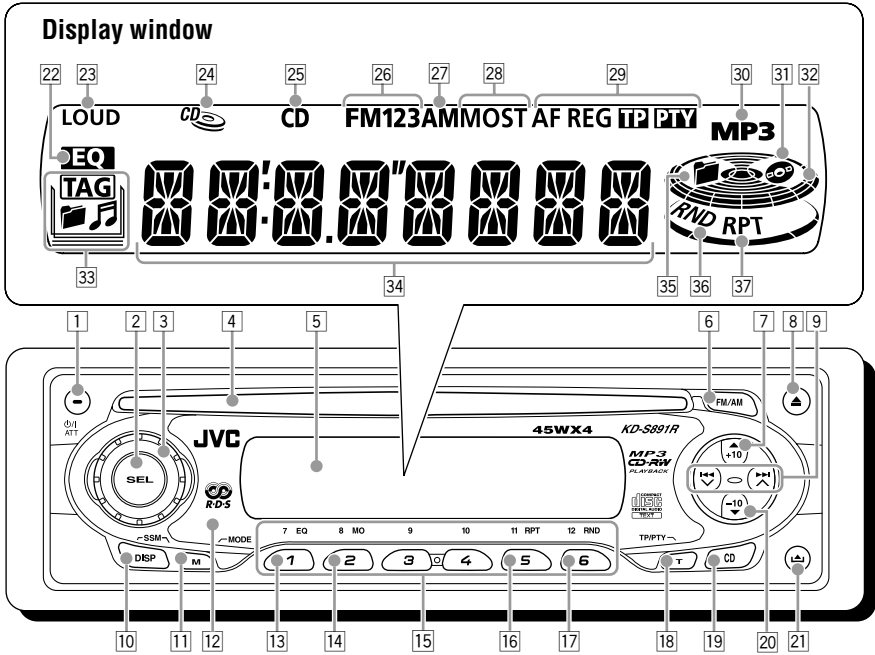

- 1  $\phi$ /I ATT (standby/on/attenuator) button
- 2 SEL (select) button
- 3 Control dial
- 4 Loading slot
- 5 Display window
- 6 FM/AM button
- 7  $\blacktriangle$  (up) button  
+10 button
- 8  $\blacktriangle$  (eject) button
- 9  $\blacktriangleleft \blacktriangleright$  buttons
- 10 DISP (display) button
  - Also functions as SSM buttons when pressed together with M (MODE) button.
- 11 M (MODE) button
  - Also functions as SSM buttons when pressed together with DISP (display) button.
- 12 Remote sensor
- 13 EQ (equalizer) button
- 14 MO (monaural) button
- 15 Number buttons
- 16 RPT (repeat) button
- 17 RND (random) button
- 18 T (TP/PTY: traffic programme/programme type) button
- 19 CD button

- 20  $\blacktriangledown$  (down) button  
-10 button
- 21  $\blacktriangle$  (control panel release) button

### Display window

- 22 EQ (equalizer) indicator
- 23 LOUD (loudness) indicator
- 24 CD-in indicator
- 25 CD indicator
- 26 FM band indicators (FM1, FM2, FM3)
- 27 AM band indicator
- 28 Tuner reception indicators  
MO (monaural), ST (stereo)
- 29 RDS indicators  
AF, REG, TP, PTY
- 30 MP3 indicator
- 31  $\text{CD}$  (disc) indicator
- 32 Volume (or audio) level indicator
- 33 Disc information indicators  
TAG (ID3 tag),  $\text{CD}$  (folder),  $\text{MP}$  (track/file)
- 34 Main display
- 35  $\text{CD}$  (folder) indicator
- 36 RND (random) indicator
- 37 RPT (repeat) indicator

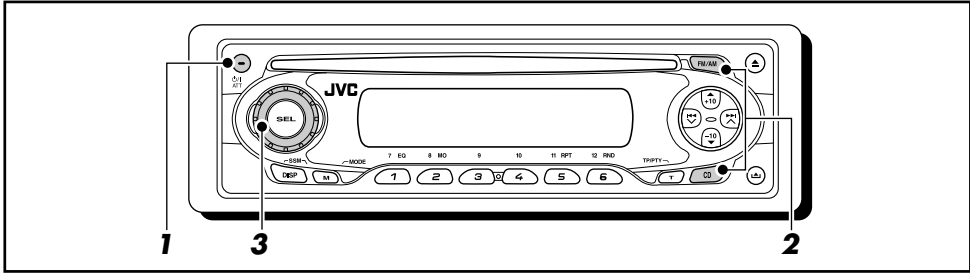

## Turning on the power

### 1 Turn on the power.



#### Note on One-Touch Operation:

When you select a source in step 2 below, the power automatically comes on. You do not have to press this button to turn on the power.

### 2 Select the source.

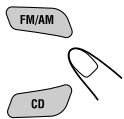

To operate the tuner (FM or AM), see pages 7 – 16.

To play a CD, see pages 17 – 20.

To operate an MP3 disc, see pages 23 – 27.

### 3 Adjust the volume.

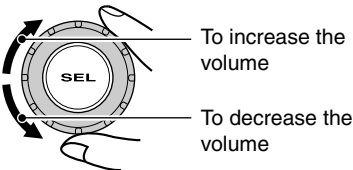

Volume (or audio) level indicator (see page 32)



Volume level appears.

### 4 Adjust the sound as you want. (See pages 28 and 29.)

#### To drop the volume in a moment

Press  $\phi$ /I ATT briefly while listening to any source. "ATT" starts flashing on the display, and the volume level will drop in a moment.

To resume the previous volume level, press the button briefly again.

- If you turn the control dial, you can also restore the sound.

#### To turn off the power

Press and hold  $\phi$ /I ATT for more than one second.

"SEE YOU" appears, then the unit turns off.

- **If you turn off the power while listening to a disc**, disc play will start from where playback has been stopped previously, next time you turn on the power.

#### CAUTION on Volume Setting:

Discs produce very little noise compared with other sources. If the volume level is adjusted for the tuner, for example, the speakers may be damaged by the sudden increase in the output level. Therefore, lower the volume before playing a disc and adjust it as required during playback.



## Setting the clock

You can also set the clock system to either 24 hours or 12 hours.

- 1 Press and hold SEL (select) for more than 2 seconds so that one of the PSM items appears on the display. (PSM: see page 31.)**



- 2 Set the hour.**

1 Select "CLOCK H" (hour) if not shown on the display.

2 Adjust the hour.

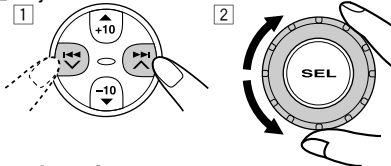

- 3 Set the minute.**

1 Select "CLOCK M" (minute).

2 Adjust the minute.

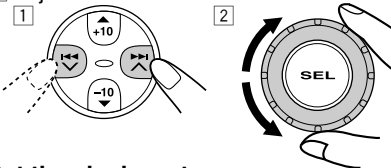

- 4 Set the clock system.**

1 Select "24H/12H."

2 Select "24H" or "12H."

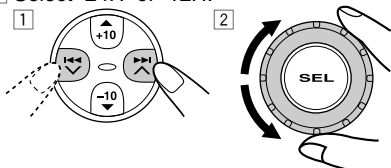

- 5 Finish the setting.**



To check the current clock time or change the display mode

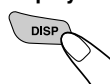

Press DISP (display) repeatedly. Each time you press the button, the display mode changes as follows:

- During tuner operation:

Frequency ↔ Clock

**Note:**

For the indication change during RDS operation, see page 15.

- During disc operation:

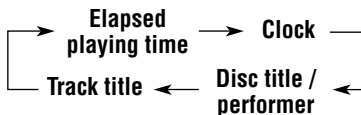

**Notes:**

- While playing a conventional CD, "NO NAME" appears for the disc title/performer and the track title.
- For indication change while playing a CD Text or an MP3 disc, see also pages 20 and 24.
- During power off:  
The power turns on and the clock time is shown for 5 seconds, then the power turns off.

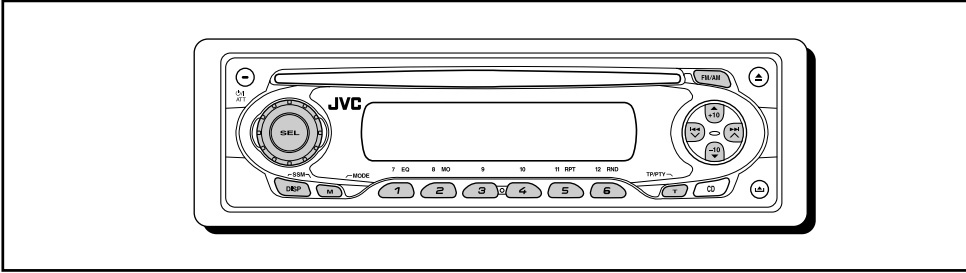

## Listening to the radio

You can use either automatic searching or manual searching to tune in to a particular station.

### Searching a station automatically: Auto search

#### 1 Select the band (FM1 – 3, AM).

Each time you press the button, the band changes as follows:

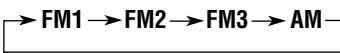

Selected band appears.

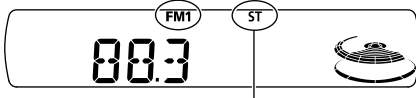

Lights up when receiving an FM stereo broadcast with sufficient signal strength.

#### Note:

This receiver has three FM bands (FM1, FM2, FM3). You can use any one of them to listen to an FM broadcast.

#### 2 Start searching a station.

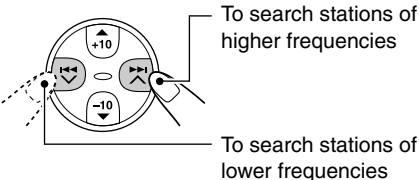

When a station is received, searching stops.

To stop searching before a station is received, press the same button you have pressed for searching.

### Searching a station manually: Manual search

#### 1 Select the band (FM1 – 3, AM).

Each time you press the button, the band changes as follows:

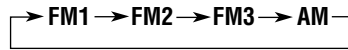

#### Note:

This receiver has three FM bands (FM1, FM2, FM3). You can use any one of them to listen to an FM broadcast.

#### 2 Press and hold **▶▶** **▲** or **◀◀** **▼** until "M" (manual) starts flashing on the display.

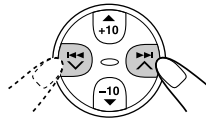



### 3 Tune in to a station you want while “M” (manual) is flashing.

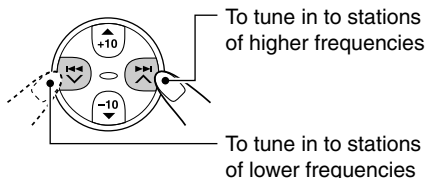

- If you release your finger from the button, the manual mode will automatically turn off after 5 seconds.
- If you hold down the button, the frequency keeps changing (in 50 kHz intervals for FM and 9 kHz intervals for AM—MW/LW) until you release the button.

### When an FM stereo broadcast is hard to receive:



1 Press M (MODE) to enter the functions mode while listening to an FM stereo broadcast.

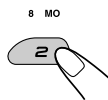

2 Press MO (monaural), while still in the functions mode, so that the MO indicator lights up on the display. Each time you press the button, the MO indicator lights up and goes off alternately.

MO (monaural) indicator

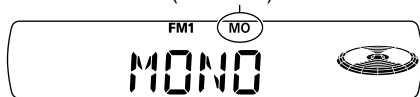

When the MO indicator is lit on the display, the sound you hear becomes monaural but the reception will be improved.

## Storing stations in memory

You can use one of the following two methods to store broadcasting stations in memory.

- Automatic preset of FM stations: SSM (Strong-station Sequential Memory)
- Manual preset of both FM and AM stations

### FM station automatic preset: SSM

You can preset 6 local FM stations in each FM band (FM1, FM2, and FM3).

#### 1 Select the FM band (FM1 – 3) you want to store FM stations into.



Each time you press the button, the band changes as follows:

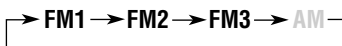

#### 2 Press and hold both buttons for more than 2 seconds.

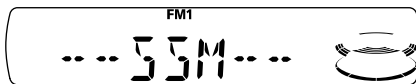
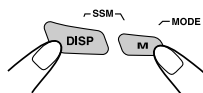

“-SSM-” appears, then disappears when automatic preset is over.

Local FM stations with the strongest signals are searched and stored automatically in the band number you have selected (FM1, FM2, or FM3).

These stations are preset in the number buttons—No.1 (lowest frequency) to No.6 (highest frequency).

When automatic preset is over, the station stored in number button 1 will be automatically tuned in.



## Manual preset

You can preset up to 6 stations in each band (FM1, FM2, FM3, and AM) manually.

Ex.: Storing FM station of 92.5 MHz into the preset number 1 of the FM1 band.

### 1 Select the band (FM1 – 3, AM) you want to store stations into (in this example, FM1).

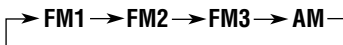
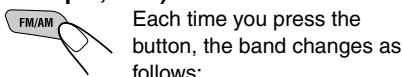

### 2 Tune in to a station (in this example, of 92.5 MHz).

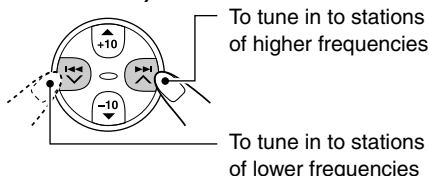

### 3 Press and hold the number button (in this example, 1) for more than 2 seconds.

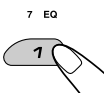

"P1" flashes for a few seconds.

### 4 Repeat the above procedure to store other stations into other preset numbers.

#### Notes:

- A previously preset station is erased when a new station is stored in the same preset number.
- Preset stations are erased when the power supply to the memory circuit is interrupted (for example, during battery replacement). If this occurs, preset the stations again.

## Tuning in to a preset station

You can easily tune in to a preset station. Remember that you must store stations first. If you have not stored them yet, see "Storing stations in memory" on pages 8 and 9.

### 1 Select the band (FM1 – 3, AM).

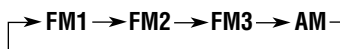
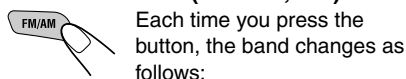

### 2 Select the number (1 – 6) for the preset station you want.

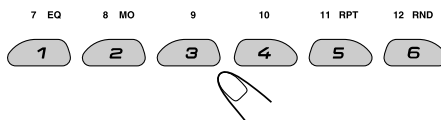

#### Note:

You can also use the ▲ (up) or ▼ (down) button on the unit to select the next or previous preset stations. Each time you press the ▲ (up) or ▼ (down) button, the next or previous preset station is tuned in.



## What you can do with RDS

RDS (Radio Data System) allows FM stations to send an additional signal along with their regular programme signals. For example, the stations send their station names, as well as information about what type of programme they broadcast, such as sports or music, etc.

Another advantage of RDS function is called "Enhanced Other Networks." By using the Enhanced Other Networks data sent from a station, you can tune in to a different station of a different network broadcasting your favorite programme or traffic announcement while listening to another programme or to another source such as CD.

By receiving the RDS data, this unit can do the following:

- Tracing the same programme automatically (Network-Tracking Reception)
- Standby Reception of TA (Traffic Announcement) or your favorite programme
- PTY (Programme Type) search
- Programme search
- And some other functions

### Tracing the same programme automatically (Network-Tracking Reception)

When driving in an area where FM reception is not good, the tuner built in this unit automatically tunes in to another RDS station, broadcasting the same programme with stronger signals. So, you can continue to listen to the same programme in its finest reception, no matter where you drive. (See the illustration on page 16.)

Two types of the RDS data are used to make Network-Tracking Reception work correctly —PI (Programme Identification) and AF (Alternative Frequency).

Without receiving these data correctly from the RDS station you are listening to, Network-Tracking Reception will not operate.

### To use Network-Tracking Reception

You can select the different modes of network-tracking reception to continue listening to the same programme in its finest reception. When shipped from the factory, "AF" is selected.

- AF: Network-Tracking Reception is activated with Regionalization set to "off." With this setting, the unit switches to another station within the same network when the receiving signals from the current station become weak. (In this mode, the programme may differ from the one currently received.) The AF indicator lights up but the REG indicator does not.
- AF REG: Network-Tracking Reception is activated with Regionalization set to "on." With this setting, the unit switches to another station, within the same network, broadcasting the same programme when the receiving signals from the current station become weak. Both the AF indicator and the REG indicator light up.
- OFF: Network-Tracking Reception is deactivated. Neither the AF indicator nor the REG indicator lights up.

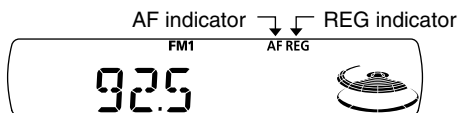



**1** Press and hold SEL (select) for more than 2 seconds so that one of the PSM items appears on the display. (PSM: see page 31.)



**2** Select “AF-REG” (alternative frequency/regionalization reception) if not shown on the display.

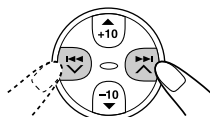

**3** Select the desired mode—“AF,” “AF REG,” or “OFF.”

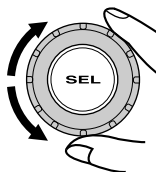

**4** Finish the setting.



## Using TA Standby Reception

TA Standby Reception allows the unit to switch temporarily to Traffic Announcement (TA) from the current source (another FM station or CD).

- TA Standby Reception will not work if you are listening to an AM station.

Press T (TP/PTY) to activate TA Standby Reception.

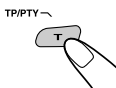

■ When the current source is FM, the TP indicator either lights up or flashes.

- If the TP indicator lights up, TA Standby Reception is activated.

If a station starts broadcasting a traffic announcement, “TRAFFIC” appears on the display, and this unit automatically tunes in to the station. The volume changes to the preset TA volume level (see page 15) and the traffic announcement can be heard.

- If the TP indicator flashes, TA Standby Reception is not yet activated since the station being received does not provide the signals used for TA Standby Reception. To activate TA Standby Reception, you need to tune in to another station providing these signals. Press ►► ▲ or ◀◀ ▼ to search for such a station.

When a station providing these signals is tuned in, the TP indicator stops flashing and remains lit. Now TA Standby Reception is activated.

■ When the current source is other than FM, the TP indicator lights up.

If a station starts broadcasting a traffic announcement, “TRAFFIC” appears on the display, and this unit automatically changes the source and tunes in to the station.

**To deactivate the TA Standby Reception,** press T (TP/PTY) again. The TP indicator goes off.



## Using PTY Standby Reception

PTY Standby Reception allows the unit to switch temporarily to your favorite programme (PTY: Programme Type) from the current source (another FM station or CD).

- *PTY Standby Reception will not work if you are listening to an AM station.*

You can select your favorite programme type for PTY Standby Reception.

When shipped from the factory, PTY Standby Reception is turned off. ("OFF" is selected for PTY Standby Reception.)

- 1 Press and hold SEL (select) for more than 2 seconds so that one of the PSM items appears on the display. (PSM: see page 31.)**



- 2 Select "PTY STBY" (standby) if not shown on the display.**

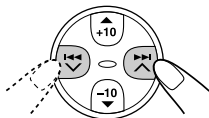

- 3 Select one of the twenty-nine PTY codes. (See page 16.)**

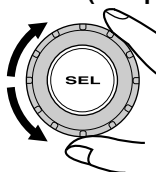

Selected code name appears on the display and is stored into memory.

- 4 Finish the setting.**



- **When the current source is FM**, the PTY indicator either lights up or flashes.

- **If the PTY indicator lights up**, PTY Standby Reception is activated.

If a station starts broadcasting the selected PTY programme, this unit automatically tunes in to the station.

- **If the PTY indicator flashes**, PTY Standby Reception is not yet activated since the station being received does not provide the signals used for PTY Standby Reception.

To activate PTY Standby Reception, you need to tune in to another station providing these signals. Press ►►| ▲ or ◀◀◀ ▼ to search for such a station.

When a station providing these signals is tuned in, the PTY indicator stops flashing and remains lit. Now PTY Standby Reception is activated.

- **When the current source is other than FM**, the PTY indicator lights up.

If a station starts broadcasting the selected PTY programme, this unit automatically changes the source and tunes in to the station.

**To deactivate the PTY Standby Reception**, select "OFF" in step 3 on the left column. The PTY indicator goes off.



## Searching your favorite programme

You can search any one of the PTY codes. In addition, you can store your 6 favorite programme types in the number buttons. When shipped from the factory, the following 6 programme types have been stored in the number buttons (1 to 6).

To store your favorite programme types, see below.

To search your favorite programme type, see page 14.

1	2	3
POP M	ROCK M	EASY M
4	5	6
CLASSICS	AFFAIRS	VARIED

### To store your favorite programme types

- 1 Press and hold T (TP/PTY) for more than 2 seconds while listening to an FM station.

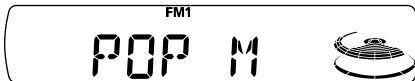
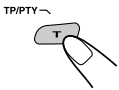

The last selected PTY code appears.

- 2 Select one of the twenty-nine PTY codes. (See page 16.)

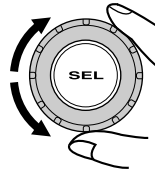

Selected code name appears on the display.

- 3 Press and hold the number button for more than 2 seconds to store the PTY code selected into the preset number you want.

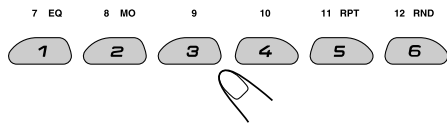

"MEMORY" and the selected code name will flash alternately.

- 4 Press and hold T (TP/PTY) for more than 2 seconds to exit from this mode.

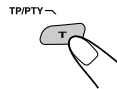



## To search your favorite programme type

- 1 Press and hold T (TP/PTY) for more than 2 seconds while listening to an FM station.

TP/PTY

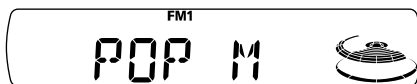

The last selected PTY code appears.

- 2 To select one of your favorite programme type

7 EQ 8 MO 9 10 11 RPT 12 RND



or

To select any one of the twenty-nine PTY codes

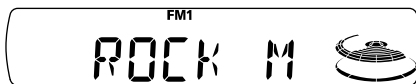
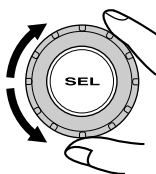

Ex.: When "ROCK M" is selected

- 3 Press **▶▶|▲** or **|◀◀▼** to start PTY search for your favorite programme.

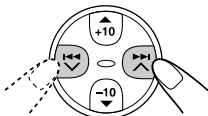

- If there is a station broadcasting a programme of the same PTY code as you selected, that station is tuned in.
- If there is no station broadcasting a programme of the same PTY code as you selected, the station will not change.

### Note:

In some areas, the PTY search will not work correctly.

## Other convenient RDS functions and adjustments

### Automatic selection of the station when using the number buttons

Usually when you press the number button, the preset station is tuned in.

However, when the preset station is an RDS station, something different will happen. If the signals from that preset station are not sufficient for good reception, this unit, using the AF data, tunes in to another frequency broadcasting the same programme as the original preset station is broadcasting. (Programme search)

- The unit takes some time to tune in to another station using programme search.

To activate programme search, follow the procedure below.

- See also "Changing the general settings (PSM)" on page 30.

- 1 Press and hold SEL (select) for more than 2 seconds so that one of the PSM items appears on the display.
- 2 Press **▶▶|▲** or **|◀◀▼** to select "P(Programme)-SEARCH."
- 3 Turn the control dial clockwise to select "ON." Now programme search is activated.
- 4 Press SEL (select) to finish the setting.

To cancel programme search, repeat the same procedure and select "OFF" in step 3 by turning the control dial counterclockwise.



## Changing the display mode while listening to an FM station

You can change the initial indication on the display to station name (PS NAME), station frequency (FREQ), or clock time (CLOCK) while listening to an FM RDS station.

- See also “Changing the general settings (PSM)” on page 30.
- 1 Press and hold SEL (select) for more than 2 seconds so that one of the PSM items appears on the display.
  - 2 Press ►►| ▲ or |◄◄ ▼ to select “TU DISP” (tuner display).
  - 3 Turn the control dial to set to the desired indication (“PS NAME,” “FREQ,” or “CLOCK”).
  - 4 Press SEL (select) to finish the setting.

### Note:

By pressing DISP (display), you can change the display while listening to an FM RDS station only. Each time you press the button, the following information appears on the display:

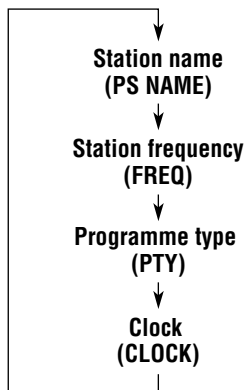

- Then, the display goes back to the original indication in several seconds.

## Setting the TA volume level

You can preset the volume level for TA Standby Reception. When a traffic programme is received, the volume level automatically changes to the preset level.

- See also “Changing the general settings (PSM)” on page 30.
- 1 Press and hold SEL (select) for more than 2 seconds so that one of the PSM items appears on the display.
  - 2 Press ►►| ▲ or |◄◄ ▼ to select “TA VOL” (TA volume).
  - 3 Turn the control dial to set to the desired volume. You can set it from “VOL 00” to “VOL 50.”
  - 4 Press SEL (select) to finish the setting.

## Automatic clock adjustment

When shipped from the factory, the clock built in this unit is set to be readjusted automatically using the CT (Clock Time) data in the RDS signal.

If you do not want to use automatic clock adjustment, follow the procedure below.

- See also “Changing the general settings (PSM)” on page 30.
- 1 Press and hold SEL (select) for more than 2 seconds so that one of the PSM items appears on the display.
  - 2 Press ►►| ▲ or |◄◄ ▼ to select “AUTO ADJ” (adjustment).
  - 3 Turn the control dial counterclockwise to select “OFF.”  
Now automatic clock adjustment is canceled.
  - 4 Press SEL (select) to finish the setting.

**To reactivate clock adjustment,** repeat the same procedure and select “ON” in step 3 by turning the control dial clockwise.

### Note:

You must stay tuned to the same station for more than 2 minutes after setting “AUTO ADJ” to “ON.” Otherwise, the clock time will not be adjusted. (This is because the unit takes up to 2 minutes to capture the CT data in the RDS signal.)



### PTY codes

NEWS:	News	SOCIAL:	Programmes on social activities
AFFAIRS:	Topical programmes expanding on current news or affairs	RELIGION:	Programmes dealing with any aspect of belief or faith, or the nature of existence or ethics
INFO:	Programmes which impart advice on a wide variety of topics	PHONE IN:	Programmes where people can express their views either by phone or in a public forum
SPORT:	Sport events	TRAVEL:	Programmes about travel destinations, package tours, and travel ideas and opportunities
EDUCATE:	Educational programmes	LEISURE:	Programmes concerned with recreational activities such as gardening, cooking, fishing, etc.
DRAMA:	Radio plays	JAZZ:	Jazz music
CULTURE:	Programmes on national or regional culture	COUNTRY:	Country music
SCIENCE:	Programmes on natural science and technology	NATION M:	Current popular music from another nation or region, in that country's language
VARIED:	Other programmes like comedies or ceremonies	OLDIES:	Classic pop music
POP M:	Pop music	FOLK M:	Folk music
ROCK M:	Rock music	DOCUMENT:	Programmes dealing with factual matters, presented in an investigative style
EASY M:	Easy-listening music		
LIGHT M:	Light music		
CLASSICS:	Classical music		
OTHER M:	Other music		
WEATHER:	Weather information		
FINANCE:	Reports on commerce, trading, the Stock Market, etc.		
CHILDREN:	Entertainment programmes for children		

The same programme can be received on different frequencies.

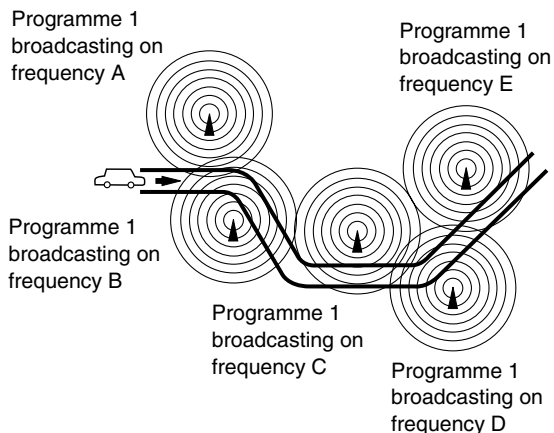



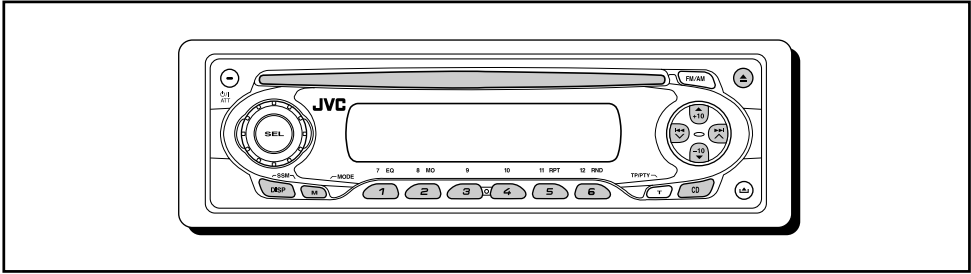

Refer to "MP3 OPERATIONS" on pages 23 to 27 for operating MP3 discs.

## Playing a CD

### Insert a CD into the loading slot.

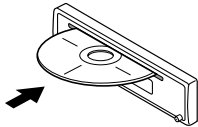

The unit turns on, draws the CD and starts playback automatically.

### Note on One-Touch Operation:

When a CD is already in the loading slot, pressing CD turns on the unit and starts playback automatically.

The CD-in indicator flashes.



The CD-in indicator lights up.

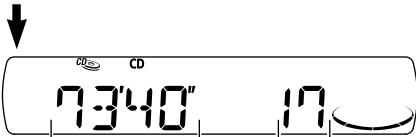
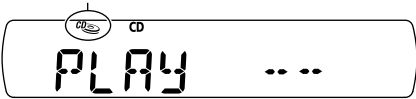

Total playing time of the inserted disc      Total track number of the inserted disc

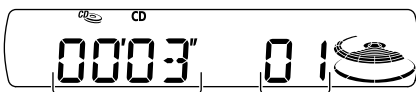

Elapsed playing time      Current track

All tracks will be played repeatedly until you stop playback.

### Note:

When a CD is inserted upside down, "EJECT" and the CD-in indicator flash on the display and the CD automatically ejects.

### To stop play and eject the CD

Press ▲.

CD play stops and the disc automatically ejects from the loading slot. The source changes to the tuner (you will hear the last received station.)

- If you change the source, CD play also stops (without ejecting the disc).

Next time you select "CD" as the source, CD play starts from where playback has been stopped previously.

### Notes:

- If the ejected disc is not removed for about 15 seconds, the disc is automatically inserted again into the loading slot to protect it from dust. (Disc play will not start this time.)
- You can eject the disc even when the unit is turned off.
- If the disc is a CD Text, disc title/performer and then track title will automatically appear.



# Locating a track or a particular portion on a CD

## To fast-forward or reverse the track

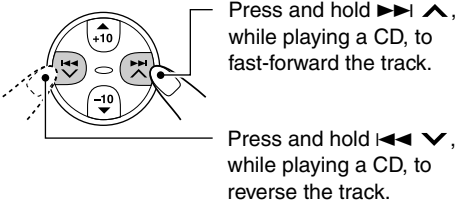

## To go to the next or previous tracks

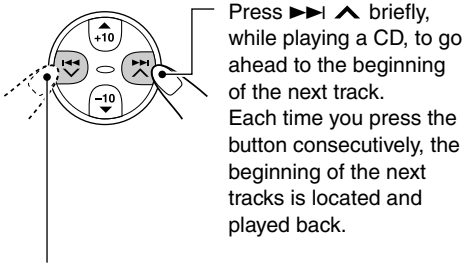

Press <<< v briefly, while playing a CD, to go back to the beginning of the current track. Each time you press the button consecutively, the beginning of the previous tracks is located and played back.

## To go to a particular track directly

Press the number button corresponding to the track number to start its playback.

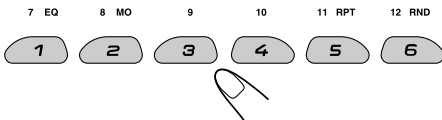

- To select a track number from 1 – 6: Press 1 (7) – 6 (12) briefly.
- To select a track number from 7 – 12: Press and hold 1 (7) – 6 (12) for more than one second.

## To go to a track quickly (+10 and –10 buttons)

- 1 Press M (MODE) to enter the functions mode while playing a CD.



- 2 Press +10 or –10.

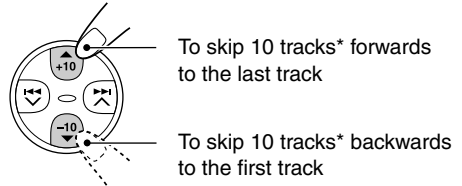

\* The first time you press +10 or –10 button, the track skips to the nearest higher or lower track with a track number of multiple ten (ex. 10th, 20th, 30th).

Then each time you press the button, you can skip 10 tracks (see “How to use the +10 and –10 buttons” below).

- After the last track, the first track will be selected, and vice versa.

### How to use the +10 and –10 buttons

- Ex. 1: To select track number 32 while playing track number 6

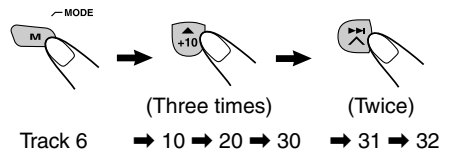

- Ex. 2: To select track number 8 while playing track number 36

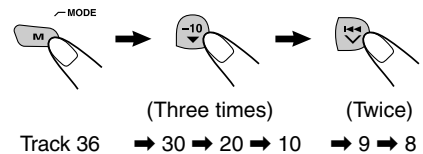



## Selecting CD playback modes

### To play back tracks at random (Disc Random Play)

You can play back all tracks on the CD at random.



- 1 Press M (MODE) to enter the functions mode while playing a CD.



- 2 Press RND (random), while still in the functions mode, so that "DISC RND" appears on the display. Each time you press the button, disc random play mode turns on and off alternately.

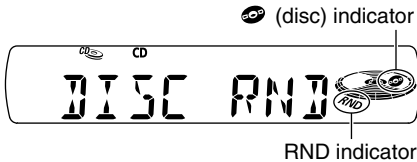

When disc random play is turned on, the  and RND indicators light up on the display. A track randomly selected starts playing.

### To play back tracks repeatedly (Track Repeat Play)

You can play back the current track repeatedly.



- 1 Press M (MODE) to enter the functions mode while playing a CD.



- 2 Press RPT (repeat), while still in the functions mode, so that "TRK RPT" appears on the display. Each time you press the button, track repeat play mode turns on and off alternately.

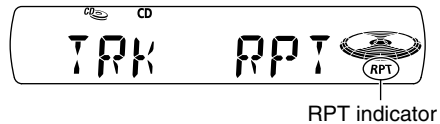

When track repeat play is turned on, the RPT indicator lights up on the display. The current track starts playing repeatedly.



## Playing a CD Text

In a CD Text, some information about the disc (its disc title, performer, and track title) is recorded. This CD Text information will be shown automatically when you play a CD Text.

**To change the CD Text information manually, select text display mode while playing a CD Text.**

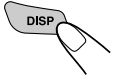

Each time you press the button, the display changes as follows:

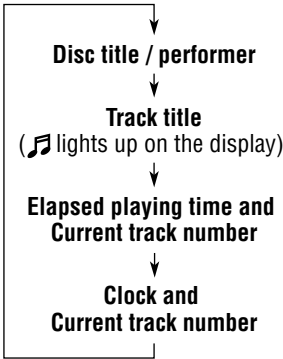

### Notes:

- The display shows up to 8 characters at a time and scrolls if there are more than 8 characters. See also “To select the scroll mode—SCROLL” on page 32. Some characters or symbols will not be shown (and be blanked) on the display. (Ex. “ABC&!d#” ⇒ “ABCA D ”)
- When you press DISP (display) while playing a conventional CD, “NO NAME” appears for the disc title/performer and the track title.

## Prohibiting disc ejection

You can prohibit disc ejection and can lock a disc in the loading slot.

**While pressing CD, press and hold ▲ for more than 2 seconds.**

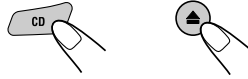

“EJECT” flashes on the display for about 5 seconds, and the disc is locked and cannot be ejected.



**To cancel the prohibition and unlock the disc**

While pressing CD, press and hold ▲ again for more than 2 seconds. “EJECT” and the CD-in indicator flash on the display, and the disc ejects from the loading slot.

The CD-in indicator flashes.





## What is MP3?

MP3 is an abbreviation of Motion Picture Experts Group (or MPEG) Audio Layer 3. MP3 is simply a file format with a data compression ratio of 1:10 (128 Kbps\*). That means, by using MP3 format, one CD-R or CD-RW can contain 10 times as much data volume as a regular CD can.

\* Bit rate is the average number of bits that one second of audio data will consume. The unit used is Kbps (1024 bits/second). To get a better audio quality, choose a higher bit rate. The most popular bit rate for encoding is 128 Kbps.

This unit is incorporated with an MP3 decoder. You can play back MP3 files (tracks) recorded on CD-Rs, CD-RWs, and CD-ROMs.

## Compatible with ID3v1 (Version 1)

Extra information data such as album title, performer name, song title, recording year, music genre and a brief comment can be stored within an MP3 file.

This unit can show ID3v1 (Version 1) tags (album name, performer name, and song title) on the display. (See page 24.)

- Some characters cannot be shown correctly.
- This unit is not compatible with ID3v2 (Version 2).

### Other main features in this unit:

- Maximum number of folders/files: 289 (Total)
- Available characters for folder/file names: A–Z, 0–9, \_ (underscore)
- Maximum number of characters for file name (ISO 9660 Level 1): 12 (inclusive of separation mark—“.” and extension code —“mp3”)
- (ISO 9660 Level 2): 31 (inclusive of separation mark—“.” and extension code —“mp3”)
- (Joliet): 64 (inclusive of separation mark —“.” and extension code —“mp3”)
- Maximum number of characters for folder name: 64

## Precautions when recording MP3 files on a CD-R or CD-RW

This unit can only read MP3 files that are recorded in the format that is compliant with ISO 9660 Level 1, Level 2, or Joliet.

## How are MP3 files recorded and played back?

MP3 “files (tracks)” can be recorded in “folders”—in PC terminology.

During recording, the files and folders can be arranged in a way similar to arranging files and folders of computer data.

“Root” is similar to the root of a tree. Every file and folder can be linked to and be accessed from the root.

Playback order, file search order, and folder search order of the MP3 files recorded on a disc are determined by the writing (or encoding) application; therefore, playback order may be different from the one you have intended while recording the folders and the files.

The illustration on the next page shows an example of how MP3 files are recorded on a CD-R or CD-RW, how they are played back, and how they are searched for on this unit.

### Notes:

- *The unit can read a CD-ROM containing MP3 files. However, if non-MP3 files are recorded together with MP3 files, this unit will take a longer time to scan the disc. It may also cause the unit to malfunction.*
- *The unit cannot read or play an MP3 file without the extension code—mp3.*
- *This player is not compatible with the data encoded with Layer 1 and Layer 2 formats.*
- *The unit is not compatible with Playlist\*\*.*

\*\* A playlist is a simple text file, used on a PC, which enables users to make their own playback order without physically rearranging the files.

## MP3 folder/file configuration

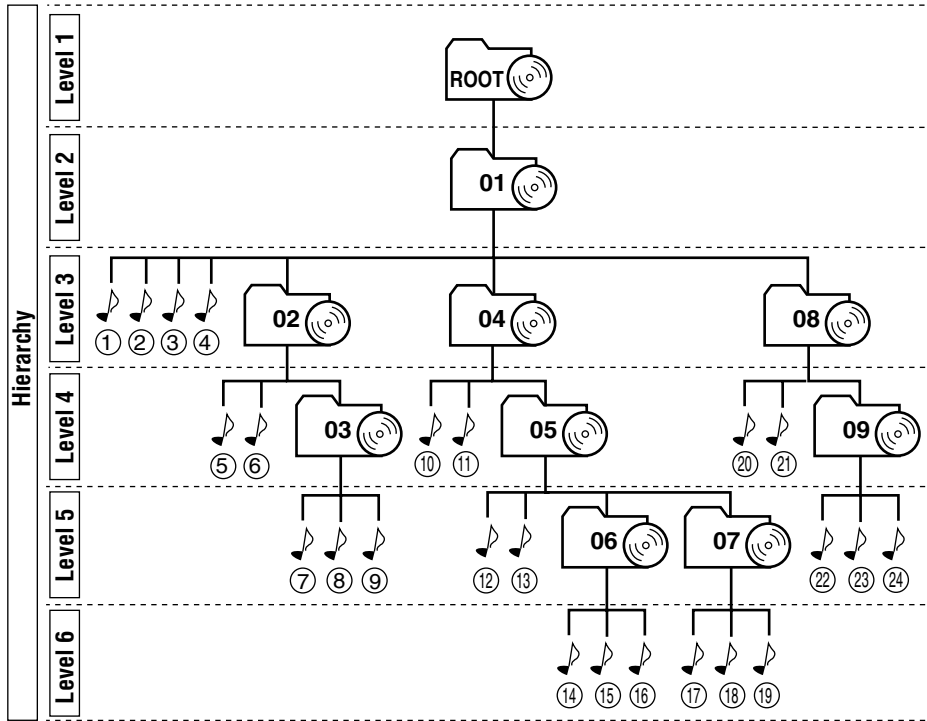

**Note:**

There is no limit on the number of the hierarchy levels (nested folders). However, up to 8 hierarchy levels is recommended for stable operations.

### MP3 playback/search order

- The numbers in circles below the MP3 files (🎵) indicate the playback order and search order of the MP3 files. Normally, this unit plays back MP3 files in the recorded order.
- The numbers inside the folders indicate the playback order and search order of the folders on an MP3 disc. Normally, this unit plays back MP3 files in the folders in the recorded order.

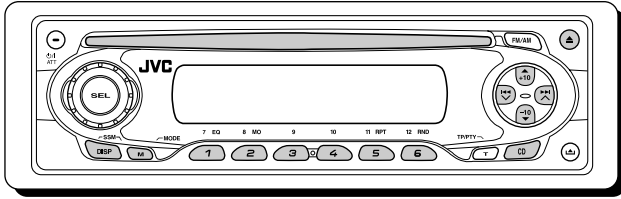

Refer also to “CD OPERATIONS” on pages 17 to 20.

## Playing an MP3 disc

Insert an MP3 disc into the loading slot.

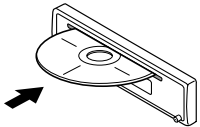

The unit turns on, draws the MP3 disc and starts playback automatically.

### Note on One-Touch Operation:

When a disc is already in the loading slot, pressing CD turns on the unit and starts playback automatically.

The CD-in indicator flashes.



↓ The CD-in indicator lights up.



↓



↓ MP3 indicator lights up.

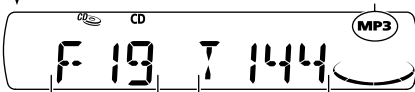

Total folder number      Total file number

Ex.: When the disc contains 19 folders and 144 MP3 files

All files will be played repeatedly until you stop playback.

### Notes:

- MP3 discs require a longer readout time. (It differs due to the complexity of the folder/file configuration.)
- When playback starts, folder and file names (or ID3 tags) will automatically appears. (See also page 24.)
- If you change the source or turn the power off, disc playback stops (without ejecting the disc). Next time you select the CD player as the source or turn the power on, disc playback starts from where playback has been stopped previously.

### To stop play and eject the disc

Press ▲.

Playback stops and the disc automatically ejects from the loading slot.

## To change the display information

While playing back an MP3 file, you can change the MP3 disc information shown on the display.

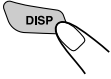

Each time you press DISP (display), the display changes to show the following:

- When “TAG DISP” is set to “TAG ON” (initial setting: see page 32)

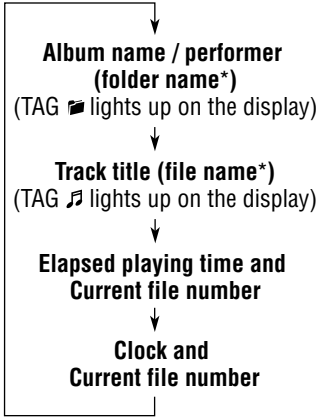

\* If an MP3 file does not have ID3 tags, folder name and file name appear. In this case, the TAG indicator will not light up on the display.

- When “TAG DISP” is set to “TAG OFF”

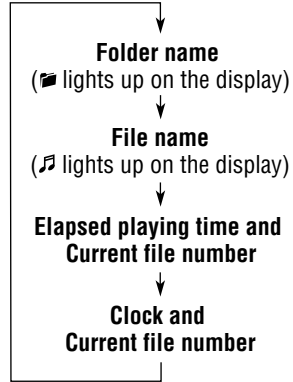

**Note:**

The display shows up to 8 characters at a time and scrolls if there are more than 8 characters. See also “To select the scroll mode—SCROLL” on page 32.



## Locating a file or a particular portion on an MP3 disc

For "MP3 playback/search order" see page 22.

### To fast-forward or reverse the file

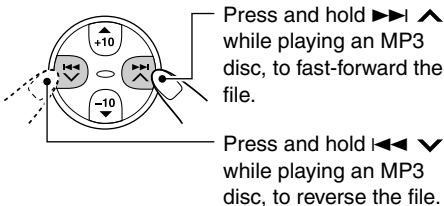

**Note:**

During this operation on an MP3 disc, you can only hear intermittent sounds. (The elapsed playing time also changes intermittently on the display.)

### To skip to the next or previous files

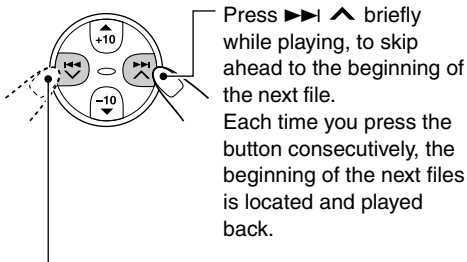

Press **◀◀|▼** briefly while playing, to skip back to the beginning of the current file. Each time you press the button consecutively, the beginning of the previous files is located and played back.

### To go to a particular file quickly within the current folder (+10 and -10 buttons)

- 1 Press M (MODE) to enter the functions mode while playing an MP3 disc.



- 2 Press +10 or -10.

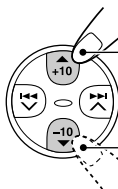

To skip 10 files\* forwards to the last file





To skip 10 files\* backwards to the first file

\* The first time you press +10 or -10 button, the file skips to the nearest higher or lower file with a file number of multiple ten (ex. 10th, 20th, 30th).

Then each time you press the button, you can skip 10 files (see "How to use the +10 and -10 buttons" below).

- After the last file, the first file will be selected, and vice versa.

#### How to use the +10 and -10 buttons

- Ex. 1: To select file number 32 while playing file number 6
  -  (Three times)  (Twice)
  - File 6 → 10 → 20 → 30 → 31 → 32
- Ex. 2: To select file number 8 while playing file number 36
  -  (Three times)  (Twice)
  - File 36 → 30 → 20 → 10 → 9 → 8

## To go to a particular folder directly

### IMPORTANT:

To directly select the folders using the number button(s), it is required that folders are assigned 2 digit numbers at the beginning of their folder names. (This can only be done during the recording of CD-Rs or CD-RWs.)

Ex.: If folder name is "01 ABC"

→ Press 1 to go to Folder 01 ABC.

If folder name is "1 ABC," pressing 1 does not work.

If folder name is "12 ABC"

→ Press and hold 6 (12) to go to Folder 12 ABC.

Press the number button corresponding to the folder number to start playing the first file in the selected folder.

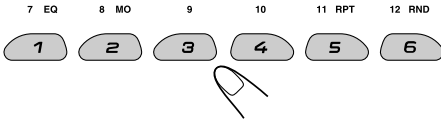

- To select a folder number from 01 – 06:  
Press 1 (7) – 6 (12) briefly.
- To select a folder number from 07 – 12:  
Press and hold 1 (7) – 6 (12) for more than one second.

### Notes:

- If "MP3" flashes on the display after you have selected a folder, it means that the folder does not contain any MP3 files.
- You cannot directly select a folder with a number greater than 12.

To select a particular file in a folder, press **▶▶** **▲** or **◀◀** **▼** after selecting the folder.

## To skip to the next or previous folder

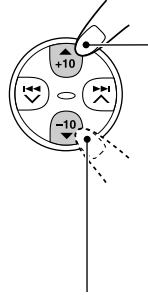

Press **▲** (up) while playing an MP3 disc to skip to the next folder.

Each time you press the button consecutively, the next folder is located (and the first file in the folder starts playing, if recorded).

Press **▼** (down) while playing an MP3 disc to skip back to the previous folder.

Each time you press the button consecutively, the previous folder is located (and the first file in the folder starts playing, if recorded).

### Note:

If the folder does not contain any MP3 files, it is skipped.

# Selecting MP3 playback modes

## To play back files at random (Folder Random/Disc Random Play)

You can play back all files of the current folder or all files on the MP3 disc at random.



**1** Press M (MODE) to enter the functions mode while playing an MP3 disc.





**2** Press RND (random), while still in functions mode, so that "FLDR RND" or "DISC RND" appears on the display. Each time you press the button, the random play mode changes as follows:



 (folder) and RND indicators

Ex.: When you select "FLDR RND"

Mode	Active indicator	Plays at random
FLDR RND	 and RND indicators light up.	All files of the current folder, then files of the next folder and so on.
DISC RND	 and RND indicators light up.	All files on the disc.

## To play back files repeatedly (Track Repeat/Folder Repeat Play)

You can play back the current file or all the files in the current folder repeatedly.



**1** Press M (MODE) to enter the functions mode while playing an MP3 disc.



**2** Press RPT (repeat), while still in functions mode, so that "TRK RPT" or "FLDR RPT" appears on the display. Each time you press the button, the repeat play mode changes as follows:



RPT indicator

Ex.: When you select "TRK RPT"

Mode	Active indicator	Plays repeatedly
TRK RPT	RPT indicator lights up.	The current (or specified) file.
FLDR RPT	 and RPT indicators light up.	All files of the current (or specified) folder.



# SOUND ADJUSTMENTS

## Selecting preset sound modes (C-EQ: custom equalizer)

You can select a preset sound mode (C-EQ: custom equalizer) suitable to the music genre.

- There is a time limit in doing the following procedure. If the setting is canceled before you finish, start from step 1 again.

### 1 Press M (MODE) to enter the functions mode.



### 2 Press EQ (equalizer), while still in the functions mode.

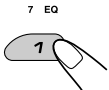

The last selected sound mode is recalled and applied to the current source.



Ex.: If you have selected "USER" previously

### 3 Select the sound mode you want.

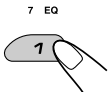

Each time you press the button, the sound modes change as follows:



The EQ indicator lights up when any sound mode other than "USER" is selected.



Ex.: When you select "ROCK"

Indication	For:	Preset values		
		BAS	TRE	LOUD
USER	(Flat sound)	00	00	OFF
ROCK	Rock or disco music	+03	+01	ON
CLASSIC	Classical music	+01	-02	OFF
POPS	Light music	+04	+01	OFF
HIP HOP	Funk or rap music	+02	00	ON
JAZZ	Jazz music	+02	+03	OFF

#### Note:

You can adjust each sound mode to your preference. Once you make an adjustment, it is automatically stored for the currently selected sound mode. See "Adjusting the sound" on page 29.

## Adjusting the sound

You can adjust the sound characteristics to your preference.

### 1 Select the item you want to adjust.



Each time you press the button, the adjustable items change as follows:

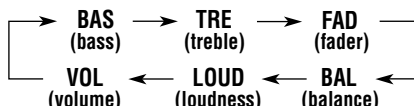

Indication	To do:	Range
BAS* <sup>1</sup>	Adjust the bass.	-06 (min.)   +06 (max.)
TRE* <sup>1</sup>	Adjust the treble.	-06 (min.)   +06 (max.)
FAD* <sup>2</sup>	Adjust the front and rear speaker balance.	R06 (Rear only)   F06 (Front only)
BAL	Adjust the left and right speaker balance.	L06 (Left only)   R06 (Right only)
LOUD* <sup>1</sup>	Boost low and high frequencies to produce a well-balanced sound at low volume level.	LOUD ON   LOUD OFF
VOL* <sup>3</sup>	Adjust the volume.	00 (min.)   50 (max.)

\*<sup>1</sup> When you adjust the bass, treble, or loudness, the adjustment you have made is stored for the currently selected sound mode (C-EQ) including "USER."

\*<sup>2</sup> If you are using a two-speaker system, set the fader level to "00."

\*<sup>3</sup> Normally the control dial work as the volume control. So you do not have to select "VOL" to adjust the volume level.

### 2 Adjust the setting.

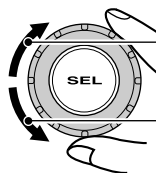

To increase the level or turn on the loudness

To decrease the level or turn off the loudness

Tone level indicator changes as you adjust the bass or treble.



Ex. 1: When you adjust "TRE" (treble)

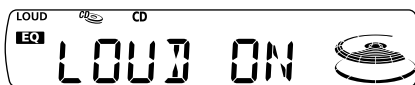

Ex. 2: When you turn on the loudness

### 3 Repeat steps 1 and 2 to adjust the other items.

**To reset each sound mode to the factory settings**, repeat the same procedure and reassign the preset values listed in the table on page 28.



# OTHER MAIN FUNCTIONS

ENGLISH

## Changing the general settings (PSM)

You can change the items listed on the next page by using the PSM (Preferred Setting Mode) control.

### Basic Procedure

- 1** Press and hold SEL (select) for more than 2 seconds so that one of the PSM items appears on the display. (See page 31.)



- 2** Select the PSM item you want to adjust.

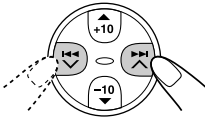

Ex.: When you select "LEVEL"

- 3** Adjust the PSM item selected.

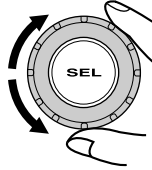

Ex.: When you select "AUDIO 2"

- 4** Repeat steps 2 and 3 to adjust the other PSM items if necessary.

- 5** Finish the setting.





## Preferred Setting Mode (PSM) items

- For detailed operations of each PSM items, refer to the pages listed in the table.

	Indications	Selectable values/items		Factory-preset settings	See page
<b>CLOCK H</b>	Hour adjustment	0 – 23 (1 – 12)		0 (0:00)	6
<b>CLOCK M</b>	Minute adjustment	00 – 59		00 (0:00)	6
<b>24H/12H</b>	24/12-hour time display	12H	24H	24H	6
<b>AUTO ADJ</b>	Automatic clock setting	OFF	ON	ON	15
<b>TU DISP</b>	Tuner display	PS NAME ↔ FREQ ↕      ↕ CLOCK      ↕		PS NAME	15
<b>AF-REG</b>	Alternative frequency/ Regionalization reception	AF ↔ AF REG ↕      ↕ OFF      ↕		AF	10, 11
<b>PTY STBY</b>	PTY standby	OFF → 29 programme types (see page 16) ↕		OFF	12
<b>TA VOL</b>	Traffic announcement volume	VOL 00 – VOL 50		VOL 20	15
<b>P-SEARCH</b>	Programme search	OFF	ON	OFF	14
<b>LEVEL</b>	Level display	AUDIO 1 ↔ AUDIO 2 ↕      ↕ OFF      ↕		AUDIO 2	32
<b>TEL</b>	Telephone muting	OFF ↔ MUTING 1 ↕      ↕ MUTING 2      ↕		OFF	32
<b>SCROLL</b>	Scroll mode	ONCE ↔ AUTO ↕      ↕ OFF      ↕		ONCE	32
<b>TAG DISP</b>	Tag display	TAG OFF	TAG ON	TAG ON	32



### To select the level meter—LEVEL

You can select the level display according to your preference.

When shipped from the factory, “AUDIO 2” is selected.

- AUDIO 1: Shows the audio level indicator.
- AUDIO 2: Alternates “AUDIO 1” setting and illumination display.
- OFF: Erases the audio level indicator.

### To select the telephone muting—TEL

This mode is used when a cellular phone system is connected. Depending on the phone system used, select either “MUTING 1” or “MUTING 2” whichever mutes the sounds from this unit.

When shipped from the factory, this mode is deactivated.

- MUTING 1: Selects this if this setting can mute the sounds while using the cellular phone.
- MUTING 2: Selects this if this setting can mute the sounds while using the cellular phone.
- OFF: Cancels the telephone muting.

### To select the scroll mode—SCROLL

You can select the scroll mode for the disc information (when the entire text cannot be shown at once).

When shipped from the factory, scroll mode is set to “ONCE.”

- ONCE: Scrolls only once.
- AUTO: Repeats the scroll (5-second intervals in between).
- OFF: Cancels scroll mode.

**Note:**

*Even if the scroll mode is set to “OFF,” you can scroll the display by pressing DISP (display) for more than one second.*

### To turn the tag display on or off—TAG DISP

An MP3 file can contain file information called “ID3 Tag” where its album name, performer, track title, etc. are recorded.

There are two versions—ID3v1 (ID3 Tag version 1) and ID3v2 (ID3 Tag version 2). Only ID3v1 can be shown.

When shipped from the factory, “TAG ON” is selected.

- TAG ON: Turns on the ID3 tag display while playing MP3 files.
  - If an MP3 file does not have ID3 tags, folder name and file name appear.
- TAG OFF: Turns off the ID3 tag display while playing MP3 files. (Only the folder name and file name can be shown.)



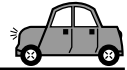

## Detaching the control panel

You can detach the control panel when leaving the car.

When detaching or attaching the control panel, be careful not to damage the connectors on the back of the control panel and on the panel holder.

### Detaching the control panel

Before detaching the control panel, be sure to turn off the power.

#### 1 Unlock the control panel.

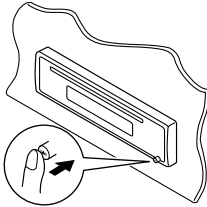

#### 2 Lift and pull the control panel out of the unit.

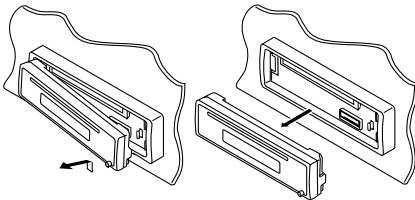

#### 3 Put the detached control panel into the provided case.

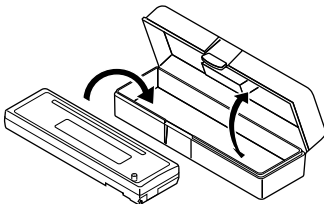

## Attaching the control panel

#### 1 Insert the left side of the control panel into the groove on the panel holder.

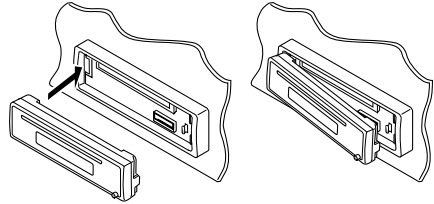

#### 2 Press the right side of the control panel to fix it to the panel holder.

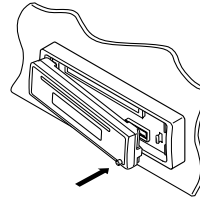

#### Note on cleaning the connectors:

If you frequently detach the control panel, the connectors will deteriorate.

To minimize this possibility, periodically wipe the connectors with a cotton swab or cloth moistened with alcohol, being careful not to damage the connectors.

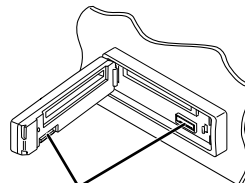

Connectors



# USING THE REMOTE CONTROLLER

This unit can be remotely controlled as instructed here (**with an optionally purchased remote controller**). We recommend that you use remote controller RM-RK50 or RM-RK60 with your unit. (Ex.: When you are using RM-RK50)

Before using the remote controller:

- Aim the remote controller directly at the remote sensor on the main unit. Make sure there is no obstacle in between.

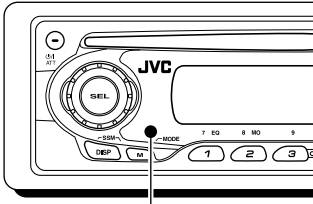

Remote sensor

- Do not expose the remote sensor to strong light (direct sunlight or artificial lighting).

## Installing the battery

When the controllable range or effectiveness of the remote controller decreases, replace the battery.

### 1. Remove the battery holder.

- 1) Push out the battery holder in the direction indicated by the arrow using a ball point pen or a similar tool.
- 2) Remove the battery holder.

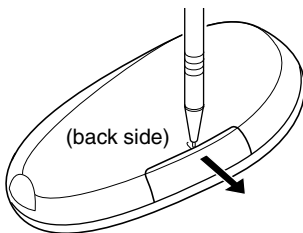

### 2. Place the battery.

Slide the battery into the holder with the + side facing upwards so that the battery is fixed in the holder.

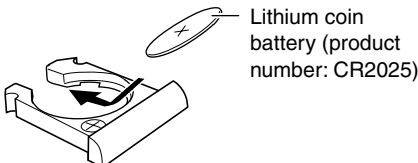

### 3. Return the battery holder.

Insert again the battery holder by pushing it until you hear a clicking sound.

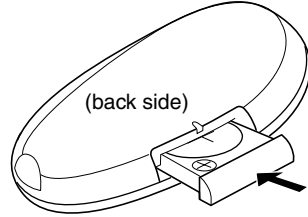

### WARNING:

- Store the battery in a place where children cannot reach.  
*If a child accidentally swallows the battery, consult a doctor immediately.*
- Do not recharge, short, disassemble, or heat the battery or dispose of it in a fire.  
*Doing any of these things may cause the battery to give off heat, crack, or start a fire.*
- Do not leave the battery with other metallic materials.  
*Doing this may cause the battery to give off heat, crack, or start a fire.*
- When throwing away or saving the battery, wrap it in tape and insulate; otherwise, the battery may start to give off heat, crack, or start a fire.
- Do not poke the battery with tweezers or similar tools.  
*Doing this may cause the battery to give off heat, crack, or start a fire.*

### CAUTION:

**DO NOT** leave the remote controller in a place (such as dashboards) exposed to direct sunlight for a long time. Otherwise, it may be damaged.



# Location of the buttons

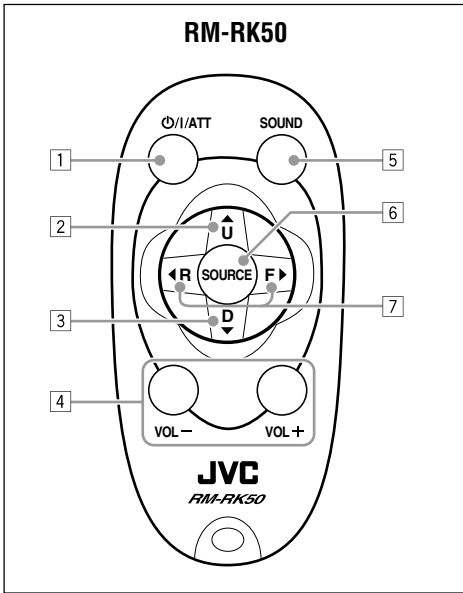

- 1 • Turns on the unit if pressed when the unit is turned off.
- Turns off the unit if pressed and held until “SEE YOU” appears on the display.
- Drops the volume level in a moment if pressed briefly.  
Press again to resume the volume.
- 2 • Selects the band while listening to the radio. Each time you press the button, the band changes.
- Skips to the first file of the next folder while listening to an MP3 disc. Each time you press the button, you can move to the next folder and start playing the first file.

- 3 • Selects the preset stations while listening to the radio. Each time you press the button, the preset station number increases, and the selected station is tuned in.
- Skips to the first file of the previous folder while listening to an MP3 disc. Each time you press the button, you can move to the previous folder and start playing the first file.
- 4 Functions the same as the control dial on the main unit.  
**Note:** These buttons do not function for the preferred setting mode adjustment.
- 5 Selects the sound mode (C-EQ: custom equalizer). Each time you press the button, the sound mode (C-EQ) changes.
- 6 Selects the source. Each time you press the button, the source changes.
- 7 • Searches for stations while listening to the radio.
- Fast-forwards or reverses the track/file if pressed and held while listening to a disc.
- Skips to the beginning of the next track/file or goes back to the beginning of the current (or previous) tracks/files if pressed briefly while listening to a disc.



# TROUBLESHOOTING

ENGLISH

What appears to be trouble is not always serious. Check the following points before calling a service center.

	Symptoms	Causes	Remedies
General	<ul style="list-style-type: none"> <li>Sound cannot be heard from the speakers.</li> </ul>	The volume level is set to the minimum level.	Adjust it to the optimum level.
		Connections are incorrect.	Check the cords and connections.
FM/AM	<ul style="list-style-type: none"> <li>This unit does not work at all.</li> </ul>	The built-in microcomputer may have functioned incorrectly due to noise, etc.	While holding SEL (select), press $\phi$ /I ATT (standby/on/attenuator) for more than 2 seconds to reset the unit. (The clock setting and preset stations stored in memory are erased.) (See page 2.)
		SSM (Strong-station Sequential Memory) automatic preset does not work.	Signals are too weak.
Disc Playback	<ul style="list-style-type: none"> <li>Static noise while listening to the radio.</li> </ul>	The aerial is not connected firmly.	Connect the aerial firmly.
		<ul style="list-style-type: none"> <li>Disc automatically ejects.</li> <li>CD-R/CD-RW cannot be played back.</li> <li>Tracks on the CD-R/CD-RW cannot be skipped.</li> </ul>	Disc is inserted upside down.
Disc Playback	<ul style="list-style-type: none"> <li>Disc can be neither played back nor ejected.</li> </ul>	CD-R/CD-RW is not finalized.	<ul style="list-style-type: none"> <li>Insert a finalized CD-R/CD-RW.</li> <li>Finalize the CD-R/CD-RW with the component which you used for recording.</li> </ul>
		Disc is locked.	Unlock the disc. (See page 20.)
Disc Playback	<ul style="list-style-type: none"> <li>Disc sound is sometimes interrupted.</li> </ul>	The CD player may function incorrectly.	While holding $\phi$ /I ATT (standby/on/attenuator), press $\blacktriangle$ (eject) for more than 2 seconds. Be careful not to drop the disc when it is ejected.
		You are driving on rough roads.	Stop playback while driving on rough roads.
Disc Playback	<ul style="list-style-type: none"> <li>"NO DISC" appears on the display.</li> </ul>	Disc is scratched.	Change the disc.
		Connections are incorrect.	Check the cords and connections.
Disc Playback	<ul style="list-style-type: none"> <li>"NO DISC" appears on the display.</li> </ul>	No disc in the loading slot.	Insert a disc into the loading slot.
		Disc is inserted incorrectly.	Insert the disc correctly.



Symptoms	Causes	Remedies
<ul style="list-style-type: none"> <li>Disc cannot be played back.</li> </ul>	No MP3 files are recorded on the disc.	Change the disc.
	MP3 files do not have the extension code—mp3 in their file names.	Add the extension code—mp3 to their file names.
	MP3 files are not recorded in the format compliant with ISO 9660 Level 1, Level 2, or Joliet.	Change the disc. (Record MP3 files using a compliant application.)
<ul style="list-style-type: none"> <li>Noise is generated.</li> </ul>	The file played back is not an MP3 file (although it has the extension code—mp3).	Skip to another file or change the disc. (Do not add the extension code—mp3 to non-MP3 files.)
<ul style="list-style-type: none"> <li>A longer readout time is required (“CHECK” keeps flashing on the display).</li> </ul>	Readout time varies due to the complexity of the folder/file configuration.	Do not use too many hierarchies and folders. Also, do not record any other types of audio tracks together with MP3 files.
<ul style="list-style-type: none"> <li>Files cannot be played back as you have intended them to play.</li> </ul>	Playback order is determined when the files are recorded.	_____
<ul style="list-style-type: none"> <li>Elapsed playing time is not correct.</li> </ul>	This sometimes occurs during play. This is caused by how the files are recorded on the disc.	_____
<ul style="list-style-type: none"> <li>“MP3” flashes on the display.</li> </ul>	The current folder does not contain any MP3 file.	Select another folder.
<ul style="list-style-type: none"> <li>“NO FILES” appears on the display.</li> </ul>	The current disc does not contain any MP3 file.	Insert a disc that contains MP3 files.
<ul style="list-style-type: none"> <li>Correct characters are not displayed (e.g. album name).</li> </ul>	This unit can only display alphabets (capital: A–Z), numbers, and a limited number of symbols.	_____

MP3 Playback

**About mistracking:**

*Mistracking may result from driving on extremely rough roads. This does not damage the unit and the disc, but will be annoying.*

*We recommend that you stop disc play while driving on such rough roads.*



# MAINTENANCE

## Handling discs

This unit has been designed to reproduce CDs, CD-Rs (Recordable), CD-RWs (Rewritable), and CD Texts.

- This unit is also compatible with MP3 discs.

### How to handle discs

**When removing a disc from its case**, press down the center holder of the case and lift the disc out, holding it by the edges.

Center holder



- Always hold the disc by the edges. Do not touch its recording surface.

**When storing a disc into its case**, gently insert the disc around the center holder (with the printed surface facing up).

- Make sure to store discs into the cases after use.

### To keep discs clean

A dirty disc may not play correctly. If a disc does become dirty, wipe it with a soft cloth in a straight line from center to edge.



### To play new discs

New discs may have some rough spots around the inner and outer edges. If such a disc is used, this unit may reject the disc.



To remove these rough spots, rub the edges with a pencil or ball-point pen, etc.

### Moisture condensation

Moisture may condense on the lens inside the CD player in the following cases:

- After starting the heater in the car.
  - If it becomes very humid inside the car.
- Should this occur, the CD player may malfunction. In this case, eject the disc and leave the unit turned on for a few hours until the moisture evaporates.

## When playing a CD-R or CD-RW

Before playing back CD-Rs or CD-RWs, read their instructions or cautions carefully.

- Use only “finalized” CD-Rs or CD-RWs.
- Some CD-Rs or CD-RWs may not play back on this unit because of their disc characteristics, and for the following reasons:
  - Discs are dirty or scratched.
  - Moisture condensation on the lens inside the unit.
  - The pickup lens inside the unit is dirty.
- CD-RWs may require a longer readout time since the reflectance of CD-RWs is lower than that of regular CDs.
- CD-Rs or CD-RWs are susceptible to high temperatures or high humidity, so do not leave them inside your car.
- Do not use following CD-Rs or CD-RWs:
  - Discs with stickers, labels, or protective seal stuck to the surface.
  - Discs on which labels can be directly printed by an ink jet printer.

Using these discs under high temperatures or high humidity may cause malfunctions or damage to discs. For example,

- Stickers or labels may shrink and warp a disc.
  - Stickers or labels may peel off so discs cannot be ejected.
  - Print on discs may get sticky.
- Read instructions or cautions about labels and printable discs carefully.

### CAUTIONS:

- Do not insert 8 cm discs (single CDs) into the loading slot. (Such discs cannot be ejected.)
- Do not insert any disc of unusual shape—like a heart or flower; otherwise, it will cause a malfunction.
- Do not expose discs to direct sunlight or any heat source or place them in a place subject to high temperature and humidity. Do not leave them in a car.
- Do not use any solvent (for example, conventional record cleaner, spray, thinner, benzine, etc.) to clean discs.

Warped disc



Sticker



Sticker residue

Disc



Stick-on label

## **AUDIO AMPLIFIER SECTION**

Maximum Power Output:

Front: 45 W per channel

Rear: 45 W per channel

Continuous Power Output (RMS):

Front: 17 W per channel into 4  $\Omega$ , 40 Hz  
to 20 000 Hz at no more than  
0.8% total harmonic distortion.

Rear: 17 W per channel into 4  $\Omega$ , 40 Hz  
to 20 000 Hz at no more than  
0.8% total harmonic distortion.

Load Impedance: 4  $\Omega$  (4  $\Omega$  to 8  $\Omega$  allowance)

Tone Control Range:

Bass:  $\pm 10$  dB at 100 Hz

Treble:  $\pm 10$  dB at 10 kHz

Frequency Response: 40 Hz to 20 000 Hz

Signal-to-Noise Ratio: 70 dB

Line-Out Level/Impedance:

2.0 V/20 k $\Omega$  load (full scale)

Output Impedance: 1 k $\Omega$

## **TUNER SECTION**

Frequency Range:

FM: 87.5 MHz to 108.0 MHz

AM: (MW) 522 kHz to 1 620 kHz

(LW) 144 kHz to 279 kHz

### **[FM Tuner]**

Usable Sensitivity:

11.3 dBf (1.0  $\mu$ V/75  $\Omega$ )

50 dB Quieting Sensitivity:

16.3 dBf (1.8  $\mu$ V/75  $\Omega$ )

Alternate Channel Selectivity (400 kHz):

65 dB

Frequency Response: 40 Hz to 15 000 Hz

Stereo Separation: 30 dB

Capture Ratio: 1.5 dB

### **[MW Tuner]**

Sensitivity: 20  $\mu$ V

Selectivity: 35 dB

### **[LW Tuner]**

Sensitivity: 50  $\mu$ V

## **CD PLAYER SECTION**

Type: Compact disc player

Signal Detection System: Non-contact optical  
pickup (semiconductor laser)

Number of channels: 2 channels (stereo)

Frequency Response: 5 Hz to 20 000 Hz

Dynamic Range: 96 dB

Signal-to-Noise Ratio: 98 dB

Wow and Flutter: Less than measurable limit

MP3 decoding format:

MPEG1/2 Audio Layer 3

Max. Bit Rate: 320 Kbps

## **GENERAL**

Power Requirement:

Operating Voltage: DC 14.4 V

(11 V to 16 V allowance)

Grounding System: Negative ground

Allowable Operating Temperature: 0°C to +40°C

Dimensions (W  $\times$  H  $\times$  D):

Installation Size (approx.):

182 mm  $\times$  52 mm  $\times$  150 mm

Panel Size (approx.):

188 mm  $\times$  58 mm  $\times$  11 mm

Mass (approx.):

1.3 kg (excluding accessories)

*Design and specifications are subject to change  
without notice.*



**Having TROUBLE with operation?**

**Please reset your unit**

Refer to page of How to reset your unit

**Haben Sie PROBLEME mit dem Betrieb?**

**Bitte setzen Sie Ihr Gerät zurück**

Siehe Seite Zurücksetzen des Geräts

**Vous avez des PROBLÈMES de fonctionnement?**

**Réinitialisez votre appareil**

Référez-vous à la page intitulée Comment réinitialiser votre appareil

**Hebt u PROBLEMEN met de bediening?**

**Stel het apparaat terug**

Zie de pagina met de paragraaf Het apparaat terugstellen

**JVC**

VICTOR COMPANY OF JAPAN, LIMITED



EN, GE, FR, NL

© 2003 VICTOR COMPANY OF JAPAN, LIMITED



0503KKSMdTJEIN



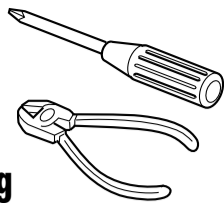

#### ENGLISH

- This unit is designed to operate on 12 V DC, NEGATIVE ground electrical systems.

## INSTALLATION (IN-DASH MOUNTING)

- The following illustration shows a typical installation. However, you should make adjustments corresponding to your specific car. If you have any questions or require information regarding installation kits, consult your JVC IN-CAR ENTERTAINMENT dealer or a company supplying kits.

- Before mounting:** Press (control panel release button) to detach the control panel if already attached.
  - \* When shipped from the factory, the control panel is packed in the hard case.
- Remove the trim plate.
- Remove the sleeve after disengaging the sleeve locks.
  - Stand the unit.
    - Note:** When you stand the unit, be careful not to damage the fuse on the rear.
  - Insert the 2 handles between the unit and the sleeve, as illustrated, to disengage the sleeve locks.
  - Remove the sleeve.
    - Note:** Be sure to keep the handles for future use after installing the unit.
- Install the sleeve into the dashboard.
  - \* After the sleeve is correctly installed into the dashboard, bend the appropriate tabs to hold the sleeve firmly in place, as illustrated.
- Fix the mounting bolt to the rear of the unit's body and place the rubber cushion over the end of the bolt.
- Do the required electrical connections.
- Slide the unit into the sleeve until it is locked.
- Attach the trim plate.
- Attach the control panel.

#### DEUTSCH

- Dieses Gerät ist für einen Betrieb in elektrischen Anlagen mit 12 V Gleichstrom und (-) Erdung ausgelegt.

## EINBAU (IM ARMATURENBRETT)

- Die folgende Abbildung zeigt einen typischen Einbau. Dennoch müssen Sie entsprechend Ihrem jeweiligen Auto Anpassungen vornehmen. Bei irgendwelchen Fragen oder wenn Sie Informationen hinsichtlich des Einbausatzes brauchen, wenden Sie sich an ihren JVC Autoradiohändler oder ein Unternehmen das diese Einbausätze vertreibt.

- Vor dem Einbau:** Drücken Sie (Freigabe der Schalttafel), um die Arretierung der Schalttafel zu lösen, sofern diese bereits angebracht ist.
  - \* Bei der Auslieferung ab Werk ist die Schalttafel im Etui verpackt.
- Den Frontrahmen herausnehmen.
- Die Halterung nach dem Entriegeln der Halterungssperren abnehmen.
  - Das Gerät aufstellen.
    - Hinweis:** Beim Aufstellen des Geräts darauf achten, daß die Sicherung auf der Rückseite nicht beschädigt wird.
  - Die 2 Griffe zwischen dem Gerät und der Halterung wie abgebildet einstecken und die Halterungssperren entriegeln.
  - Die Halterung entfernen.
    - Hinweis:** Sicherstellen, daß die Griffe für künftigen Gebrauch nach dem Einbau des Geräts aufbewahrt werden.
- Die Halterung im Armaturenbrett einbauen.
  - \* Nach dem korrekten Einbau der Halterung im Armaturenbrett, die entsprechenden Riegel umknicken, um die Halterung an ihrem Platz zu sichern, siehe Abbildung.
- Die Befestigungsschraube an der Rückseite des Gerätekörpers befestigen und das Ende der Schraube mit einem Gummipuffer abdecken.
- Nehmen Sie die erforderlichen elektrischen Anschlüsse vor.
- Das Gerät in die Halterung schieben, bis es einrastet.
- Befestigen Sie den Frontrahmen.
- Die Schalttafel anbringen.

#### FRANÇAIS

- Cet appareil est conçu pour fonctionner sur des sources de courant continu de 12 V à masse NEGATIVE.

## INSTALLATION (MONTAGE DANS LE TABLEAU DE BORD)

- L'illustration suivante est un exemple d'installation typique. Cependant, vous devez faire les ajustements correspondant à votre voiture particulière. Si vous avez des questions ou avez besoin d'information sur des kits d'installation, consulter votre revendeur d'autoradios JVC ou une compagnie d'approvisionnement.

- Avant le montage:** Appuyer sur (déblocage du panneau de commande) pour éventuellement détacher le panneau de commande.
  - \* Lorsque ce panneau de commande sort d'usine, il est rangé dans un étui de transport.
- Retirer la plaque d'assemblage.
- Libérer les verrous du manchon et retirer le manchon.
  - Poser l'appareil à la verticale.
    - Remarque:** Lorsque vous mettez l'appareil à la verticale, faire attention de ne pas endommager le fusible situé sur l'arrière.
  - Insérer les 2 poignées entre l'appareil et le manchon comme indiqué pour désengager les verrous de manchon.
  - Retirer le manchon.
    - Remarque:** S'assurer de garder les poignées pour une utilisation ultérieure, après l'installation de l'appareil.
- Installer le manchon dans le tableau de bord.
  - \* Après installation correcte du manchon dans le tableau de bord, plier les bonnes pattes pour maintenir fermement le manchon en place, comme montré.
- Monter le boulon de montage sur l'arrière du corps de l'appareil puis passer l'amortisseur en caoutchouc sur l'extrémité du boulon.
- Réalisez les connexions électriques.
- Faire glisser l'appareil dans le manchon jusqu'à ce qu'il soit verrouillé.
- Attachez la plaque d'assemblage.
- Remonter le panneau de commande.

#### NEDERLANDS

- Dit apparaat mag worden gebruikt bij elektrische systemen die werken op 12 V gelijkstroom met negatieve aarding.

## INSTALLATIE (INBOUW IN HET DASHBOARD)

- Op de volgende afbeelding kunt u zien hoe de installatie, normaal gesproken, in zijn werk gaat. U moet echter bij de installatie rekening houden met de bijzonderheden van uw eigen auto. Neem bij vragen of voor meer bijzonderheden over inbouwpakketten contact op met uw JVC car audio dealer of een dealer of een bedrijf dat inbouwpakketten levert.

- Voordat u aan de montage van het apparaat begint:** Druk op (het bedieningspaneel vrijgeven) als u het bedieningspaneel wilt loskoppelen indien dit aan de eenheid is vastgekoppeld.
  - \* Standaard wordt het bedieningspaneel bij het verlaten van de fabriek los verpakt meegeleverd.
- Verwijder de sierplaat.
- Verwijder het huis nadat u de klemmen hebt losgemaakt.
  - Zet het apparaat rechtop.
    - Opmerking:** Wanneer u het apparaat rechtop zet, moet u erop letten dat u de zekering aan de achterkant niet beschadigt.
  - Plaats de 2 hendels, zoals afgebeeld, tussen het apparaat en het huis, om de klemmen los te maken.
  - Verwijder het huis.
    - Opmerking:** Bewaar de hendels nadat u het apparaat hebt geïnstalleerd, zodat u ze ook in de toekomst kunt gebruiken.
- Installeer het huis in het dashboard.
  - \* Nadat het huis op de juiste wijze in het dashboard is geplaatst, moet u de palletjes, zoals afgebeeld, stevig op hun plaats duwen.
- Maak de bevestigingsbout aan de achterkant van het apparaat vast en plaats de rubberdop over het uiteinde van de bout.
- Breng de vereiste elektrische verbindingen tot stand.
- Schuif het apparaat in het huis totdat het vergrendeld is.
- Bevestig een sierplaat.
- Bevestig het bedieningspaneel.

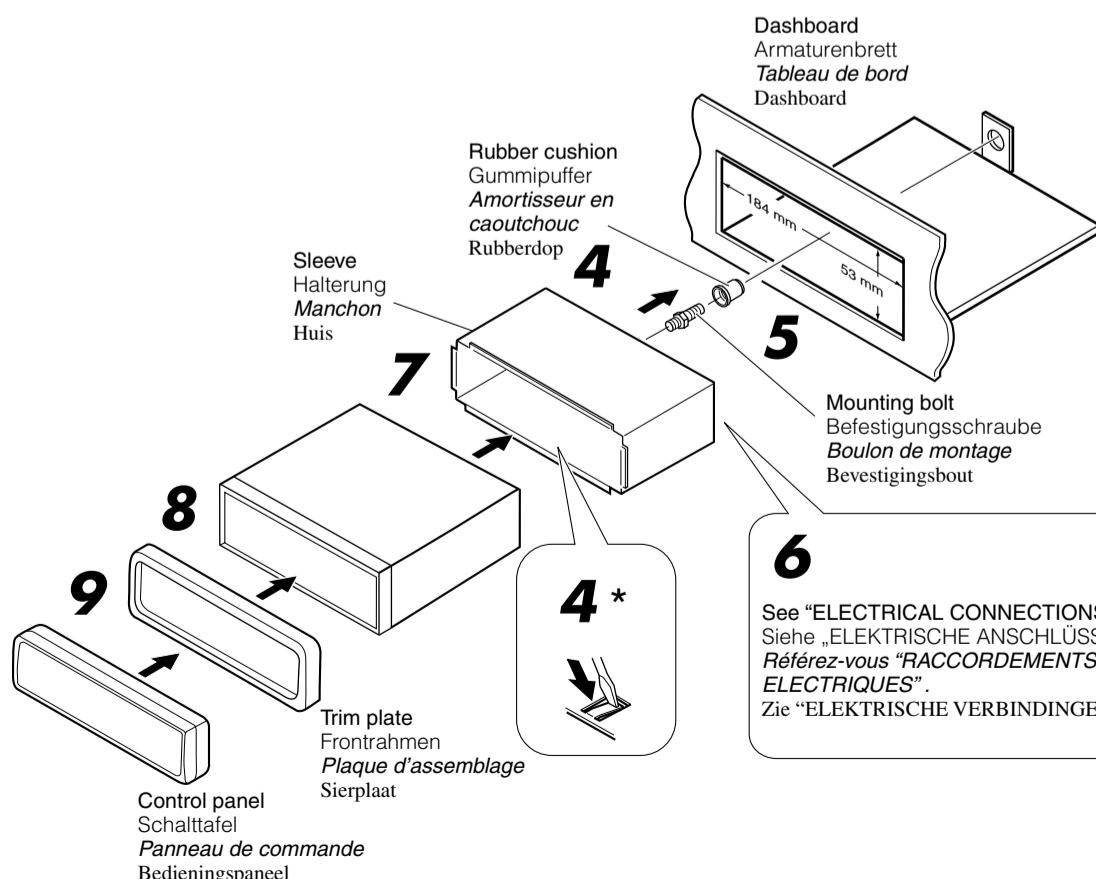
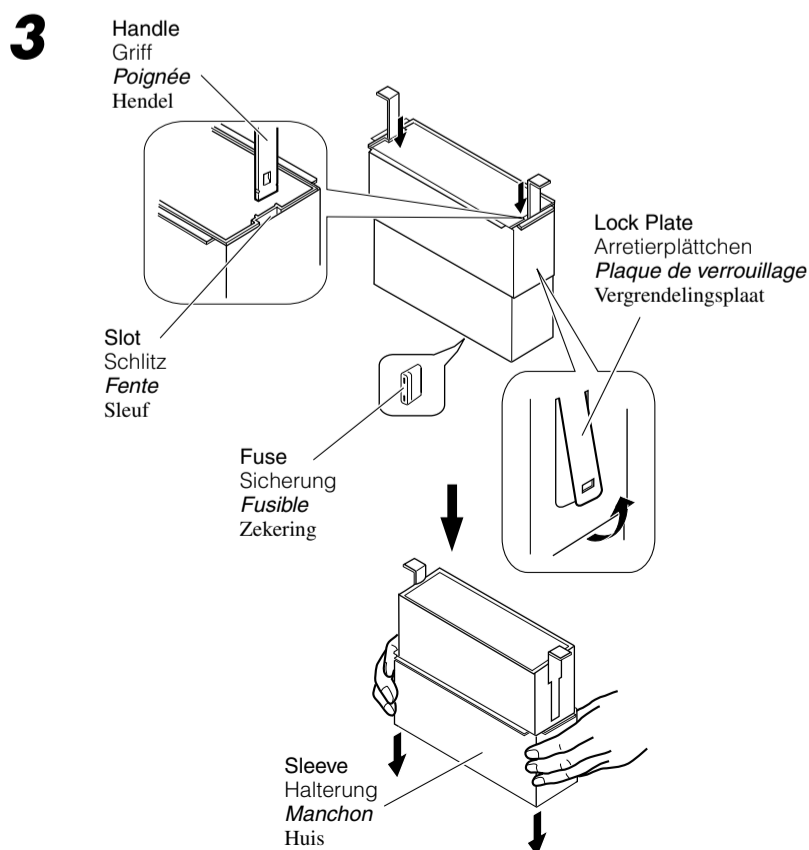
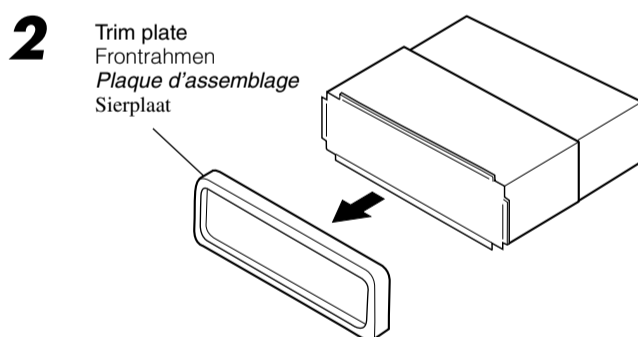
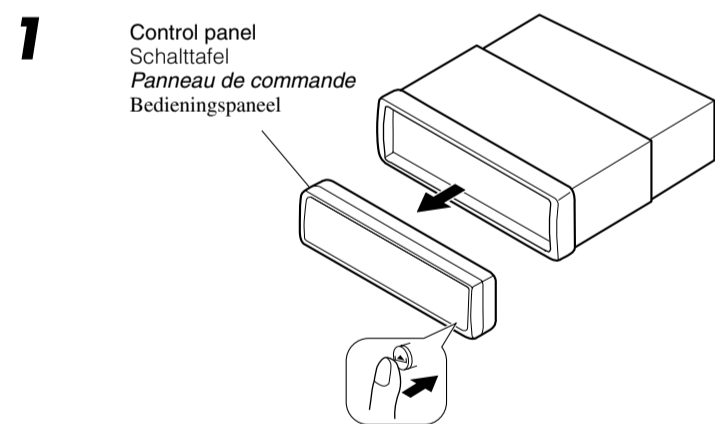

**6** See "ELECTRICAL CONNECTIONS."  
Siehe „ELEKTRISCHE ANSCHLÜSSE“.  
Référez-vous "RACCORDEMENTS  
ELECTRIQUES".  
Zie "ELEKTRISCHE VERBINDINGEN".

- When using the optional stay
- Beim Verwenden der Anker-Option
- Lors de l'utilisation du hauban en option
- Wanneer u de steun gebruikt (facultatief)

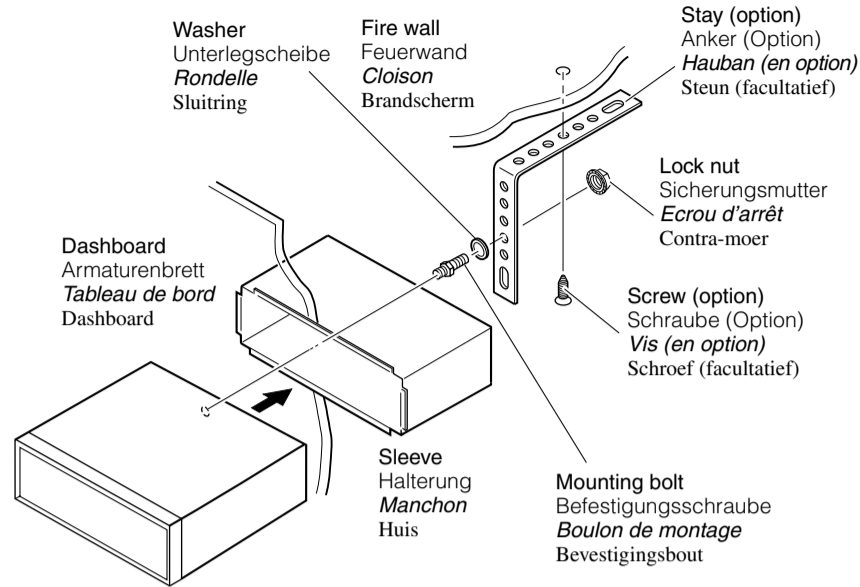

Less than 30°  
Weniger als 30°  
Moins de 30°  
Kleiner dan 30°

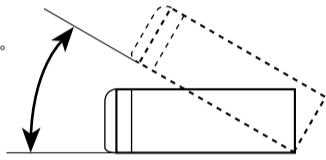

Install the unit at an angle of less than 30°.  
Stellen Sie das Gerät mit einem Winkel von weniger als 30° auf.  
Installez l'appareil avec un angle de moins de 30°.  
Installeer het toestel met een hoek kleiner dan 30°.

- When installing the unit without using the sleeve
- Beim Einbau des Geräts ohne Halterung
- Lors de l'installation de l'appareil sans utiliser de manchon
- Wanneer u het apparaat zonder huis installeert

In a Toyota for example, first remove the car radio and install the unit in its place.  
Zum Beispiel in einem Toyota zuerst das Autoradio ausbauen und dann das Gerät an seinem Platz einbauen.  
Par exemple dans une Toyota, retirer d'abord l'autoradio et installer l'appareil à la place.  
Voorbeeld: Bij een Toyota moet u eerst de autoradio verwijderen en daarna het apparaat installeren.

Flat type screws (M5 x 6 mm)\*  
Senkkopfschrauben (M5 x 6 mm)\*  
Vis à tête plate (M5 x 6 mm)\*  
Platkopschroeven (M5 x 6 mm)\*

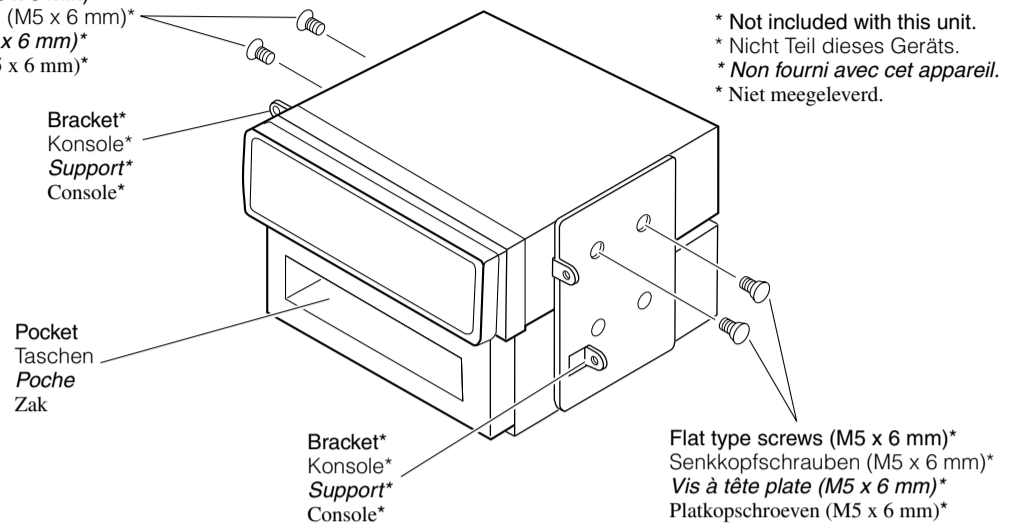

\* Not included with this unit.  
\* Nicht Teil dieses Geräts.  
\* Non fourni avec cet appareil.  
\* Niet meegeleverd.

**Note** : When installing the unit on the mounting bracket, make sure to use the 6 mm-long screws. If longer screws are used, they could damage the unit.  
**Hinweis** : Beim Anbringen des Gerät an der Konsole sicherstellen, daß 6 mm lange Schrauben verwendet werden. Werden längere Schrauben verwendet, können sie das Gerät beschädigen.  
**Remarque** : Lors de l'installation de l'appareil sur le support de montage, s'assurer d'utiliser des vis d'une longueur de 6 mm. Si des vis plus longues sont utilisées, elles peuvent endommager l'appareil.  
**Opmerking** : Wanneer u het apparaat aan de bevestigingsklem vastmaakt, moet u de 6 mm lange schroeven gebruiken. Als u langere schroeven gebruikt, kan het apparaat worden beschadigd.

### Removing the unit

- Before removing the unit, release the rear section.
- 1** Remove the control panel.
- 2** Remove the trim plate.
- 3** Insert the 2 handles into the slots, as shown. Then, while gently pulling the handles away from each other, slide out the unit. **(Be sure to keep the handles after installing it.)**

### Ausbau des Geräts

- Vor dem Ausbau des Geräts den hinteren Teil freigeben.
- 1** Den Schalttafel abnehmen.
- 2** Den Frontrahmen herausnehmen.
- 3** Die 2 Griffe in die Schlitz wie gezeigt stecken. Dann die Griffe behutsam auseinander ziehen und das Gerät herausziehen. **(Die Griffe nach dem Einbau auf jeden Fall aufbewahren.)**

### Retrait de l'appareil

- Avant de retirer l'appareil, libérer la section arrière.
- 1** Retirer le panneau de commande.
- 2** Retirer la plaque d'assemblage.
- 3** Introduire les 2 poignées dans les fentes, comme montré. Puis, tout en tirant doucement les poignées écartées, faire glisser l'appareil pour le sortir. **(S'assurer de conserver les poignées après l'installation de l'appareil.)**

### Verwijderen van het apparaat

- Voordat u het apparaat verwijderd, moet u het achtergedeelte losmaken.
- 1** Verwijder het bedieningspaneel.
- 2** Verwijder de sierplaat.
- 3** Plaats de 2 hendels, zoals afgebeeld, in de sleuven. Daarna duwt u de hendels zachtjes uit elkaar en kunt u het apparaat naar buiten schuiven. **(Bewaar de hendels nadat u het apparaat hebt geïnstalleerd!)**

**1**

Control panel  
Schalttafel  
Panneau de commande  
Bedieningspaneel

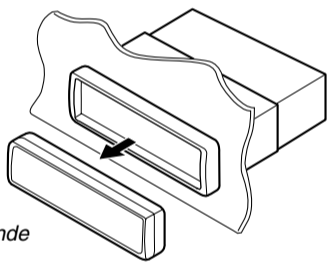

**2**

Trim plate  
Frontrahmen  
Plaque d'assemblage  
Sierplaat

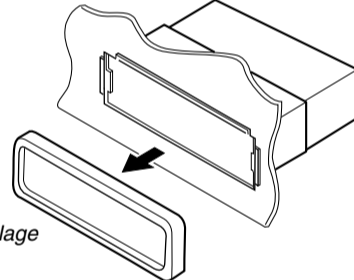

**3**

Handle  
Griff  
Poignée  
Hendel

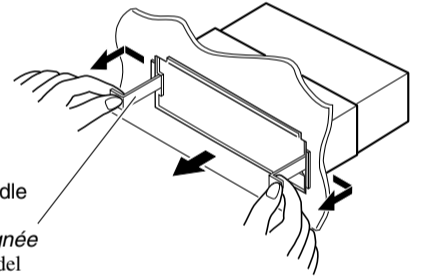

### Parts list for installation and connection

The following parts are provided with this unit. After checking them, please set them correctly.

Hard case/Control panel  
Etui/Schalttafel  
Etui de transport/Panneau de commande  
Behuizing/Bedieningspaneel

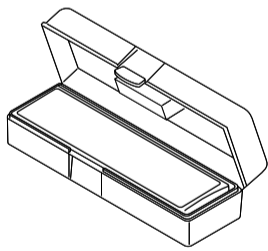

Power cord  
Stromkable  
Cordon d'alimentation  
Stroomkabel

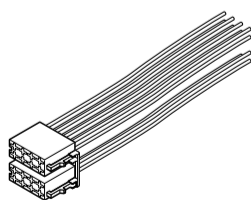

Lock nut (M5)  
Sicherungsmutter (M5)  
Ecrou d'arrêt (M5)  
Contra-moer (M5)



### Teilleiste für den Einbau und Anschluß

Die folgenden Teile werden zusammen mit diesem Gerät geliefert. Nach ihrer Überprüfung, die Teile richtig einsetzen.

Sleeve  
Halterung  
Manchon  
Huis

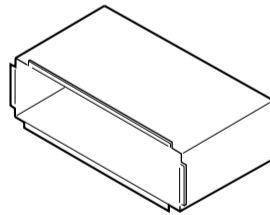

Handles  
Griffe  
Poignées  
Hendels

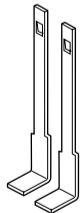

Mounting bolt (M5 x 20 mm)  
Befestigungsschraube (M5 x 20 mm)  
Boulon de montage (M5 x 20 mm)  
Bevestigingsbout (M5 x 20 mm)



### Liste des pièces pour l'installation et raccordement

Les pièces suivantes sont fournies avec cet appareil. Après vérification, veuillez les placer correctement.

### Lijst van onderdelen die u bij installatie en aansluiting nodig hebt

De volgende onderdelen worden bij het apparaat geleverd. Installeer ze op de juiste wijze, nadat u ze hebt gecontroleerd.

Trim plate  
Frontrahmen  
Plaque d'assemblage  
Sierplaat

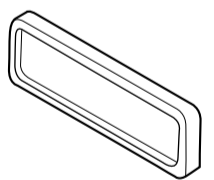

Washer (ø5)  
Unterlegscheibe (ø5)  
Rondelle (ø5)  
Sluitring (ø5)



Rubber cushion  
Gummipuffer  
Amortisseur en caoutchouc  
Rubberdop



ELECTRICAL CONNECTIONS

To prevent short circuits, we recommend that you disconnect the battery's negative terminal and make all electrical connections before installing the unit. If you are not sure how to install this unit correctly, have it installed by a qualified technician.

Note:

This unit is designed to operate on 12 V DC, **NEGATIVE ground electrical systems**. If your vehicle does not have this system, a voltage inverter is required, which can be purchased at JVC IN-CAR ENTERTAINMENT dealers.

- Replace the fuse with one of the specified rating. If the fuse blows frequently, consult your JVC IN-CAR ENTERTAINMENT dealer.
- If noise is a problem...

This unit incorporates a noise filter in the power circuit. However, with some vehicles, clicking or other unwanted noise may occur. If this happens, connect the unit's **rear ground terminal** (see connection diagram) to the car's chassis using shorter and thicker cords, such as copper braiding or gauge wire. If noise still persists, consult your JVC IN-CAR ENTERTAINMENT dealer.

- Maximum input of the speakers should be more than 45 W at the rear and 45 W at the front, with an impedance of 4 Ω to 8 Ω.
- **Be sure to ground this unit to the car's chassis.**
- The heat sink becomes very hot after use. Be careful not to touch it when removing this unit.

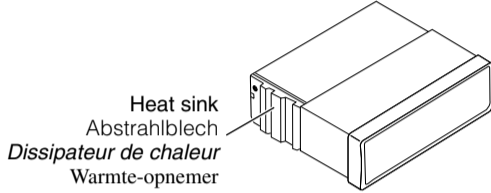

ELEKTRISCHE ANSCHLÜSSE

Zur Vermeidung von Kurzschlüssen empfehlen wir, daß Sie den negativen Batterieanschluß abtrennen und alle elektrischen Anschlüsse herstellen, bevor das Gerät eingebaut wird. Sind Sie sich über den richtigen Einbau des Geräts nicht sicher, lassen Sie es von einem qualifizierten Techniker einbauen.

Hinweis:

Dieses Gerät ist für einen Betrieb in **elektrischen Anlagen mit 12 V Gleichstrom und (-) Erdung ausgelegt**. Verfügt Ihr Fahrzeug nicht über diese Anlage, ist ein Spannungsinverter erforderlich, der bei JVC Autoradiohändler erworben werden kann.

- Die Sicherung mit einer der entsprechenden Nennleistung ersetzen. Brennt die Sicherung häufig durch, wenden Sie sich an ihren JVC Autoradiohändler.
- Sind Störgeräusche ein Problem...

Dieses Gerät enthält ein Störfilter im Stromkreis. Bei manchen Fahrzeugen kann jedoch ein Klicken oder andere unerwünschte Störgeräusche auftreten. Sollte das der Fall sein, die **hintere Erdungscanschlußklemme** (siehe Schaltplan) des Geräts am Fahrwerk des Fahrzeugs anschließen, dabei kürzere und dickere Kabel wie beispielsweise Kupfergeflecht draht oder Stahldraht verwenden. Bleibt Störgeräusch bestehen, wenden Sie sich an Ihren JVC Autoradiohändler.

- Die maximale Eingangsleistung der Lautsprecher sollte mehr als 45 W hinten und 45 W vorn bei einer Impedanz von 4 Ω bis 8 Ω betragen.
- **Sicherstellen, daß das Gerät am Fahrwerk geerdet wird.**
- Das Abstrahlblech wird nach dem Gebrauch sehr heiß. Beim Ausbau des Geräts darauf achten, das Abstrahlblech nicht zu berühren.

RACCORDEMENTS ELECTRIQUES

Pour éviter tout court-circuit, nous vous recommandons de débrancher la borne négative de la batterie et d'effectuer tous les raccordements électriques avant d'installer l'appareil. Si l'on n'est pas sûr de pouvoir installer correctement cet appareil, le faire installer par un technicien qualifié.

Remarque:

Cet appareil est conçu pour fonctionner sur des sources de courant continu de 12 V à masse **NEGATIVE**. Si votre véhicule n'offre pas ce type d'alimentation, il vous faut un convertisseur de tension, que vous pouvez acheter chez un revendeur d'autoradios JVC.

- Remplacer le fusible par un de la valeur précisée. Si le fusible saute souvent, consulter votre revendeur d'autoradios JVC.
- Si le bruit est un problème...

Cet appareil incorpore un filtre de bruit dans le circuit d'alimentation. Cependant, avec certains véhicules, quelques claquements ou autres bruits non désirés risquent de se produire. Si cela arrive, raccorder la borne arrière de masse de l'appareil au châssis de la voiture (voir le diagramme de raccordement) en utilisant des cordons les plus gros et les plus courts possibles telle qu'une barre de cuivre ou une tresse. Si le bruit persiste, consulter votre revendeur d'autoradios JVC.

- La puissance admissible des enceintes devrait supérieure à 45 W à l'arrière et à 45 W l'avant, avec une impédance de 4 Ω à 8 Ω.
- **S'assurer de raccorder la mise à la masse de cet appareil au châssis de la voiture.**
- Le dissipateur de chaleur devient très chaud après usage. Faire attention de ne pas le toucher en retirant cet appareil.

ELEKTRISCHE VERBINDINGEN

Om kortsluiting te voorkomen adviseren wij u om de minpool van de accu los te maken en alle elektrische verbindingen tot stand te brengen voordat u het apparaat in de auto installeert. Als u niet zeker weet hoe u dit apparaat moet installeren, kunt u dit beter door een daartoe gekwalificeerde technicus laten doen.

Opmerking:

Dit apparaat mag worden gebruikt bij elektrische systemen die werken op 12 V gelijkstroom met negatieve aarding. Als uw auto niet is uitgerust met een dergelijk systeem, is een spanningsomzetter vereist. Dit instrument kan worden aangeschaft bij JVC car audio dealers.

- Vervang de zekering door een exemplaar met het aangegeven vermogen. Als de zekering vaak doorslaat, moet u uw JVC car audio dealer raadplegen.
- Als u geluidsproblemen hebt...

De krachtschakeling van dit apparaat heeft een ingebouwd geluidsfilter. In sommige voertuigen zijn tikgeluiden of andere ongewenste geluiden te horen. Als dit gebeurt, moet u de **massaklem aan de achterkant** (zie aansluitingsschema) aan het chassis van de auto vastmaken met behulp van een kortere en dikkere kabel, zoals kopermanteldraad of tellerkabel. Als het geluid niet verdwijnt, moet u contact opnemen met uw JVC car audio dealer.

- Het maximum ingangsvormogen van de speakers moet achterin meer dan 45 W zijn en voorin 45 W, met een impedantie van 4 Ω tot 8 Ω.
- **Zorg ervoor dat dit apparaat door middel van een aardkabel is verbonden met het chassis van de auto.**
- De warmte-opnemer kan na gebruik erg heet worden. Raak de warmte-opnemer niet aan wanneer u dit apparaat van zijn plaats haalt.

Typical Connections / Typische Anschlüsse / Raccordements typiques / Normale verbindingen

**Before connecting:** Check the wiring in the vehicle carefully. Incorrect connection may cause serious damage to this unit.

The leads of the power cord and those of the connector from the car body may be different in color.

- 1 Connect the colored leads of the power cord to the car battery, speakers and power aerial (if any) in the following sequence.

- ① Black: ground
- ② Yellow: to car battery (constant 12 V)
- ③ Red: to an accessory terminal
- ④ Blue with white stripe: to remote lead of other equipment or power aerial if any (200 mA max.)
- ⑤ Brown: to cellular phone system (For details, refer to the instructions of the cellular phone.)
- ⑥ Others: to speakers

- 2 Connect the aerial cord.

- 3 Finally connect the wiring harness to the unit.

**Note:** If your vehicle does not have any accessory terminal, move the fuse from the fuse position 1 (initial position) to fuse position 2, and connect the red lead (A7) to the positive (+) battery terminal.

- The yellow lead (A4) is not used in this case.

**Vor dem Anschließen:** Die Verdrahtung im Fahrzeug sorgfältig überprüfen. Falsche Anschlüsse können ernsthafte Schäden am Gerät hervorrufen.

Die Leiter des Stromkabels und die Leiter des Anschlusses im Fahrzeug können sich farblich unterscheiden.

- 1 Die farbigen Leitungen des Spannungsvorsorgungskabels an der Autobatterie, den Lautsprechern und dem Motorantenne (sofern vorhanden) in folgender Reihenfolge anschließen.

- ① Schwarz: Erdung
- ② Gelb: an Autobatterie (konstant 12 V)
- ③ Rot: zur einer Zubehörananschlußklemme
- ④ Blau mit weißem Streifen: zum Zusatzkabel des anderen Geräts oder der Motorantenne, sofern vorhanden (max. 200 mA)
- ⑤ Braun: an Mobiltelefon (Weitere Informationen entnehmen Sie bitte der Bedienungsanleitung des Mobiltelefons.)
- ⑥ Andere: zur Lautsprecher

- 2 Das Antennenkabel anschließen.

- 3 Die Kabelbäume am Gerät anschließen.

**Hinweis:** Verfügt Ihr Fahrzeug nicht über eine Zubehörananschlußklemme, die Sicherung von der 1. Sicherungsposition (Erstposition) in die 2. Sicherungsposition versetzen, die rote Leitung (A7) an der (+) Batterieanschlußklemme anschließen.

- Die gelbe Leitung (A4) wird in diesem Fall nicht verwendet.

**Avant de commencer la connexion:** Vérifier attentivement le câblage du véhicule. Une connexion incorrecte peut endommager sérieusement l'appareil. Le fil du cordon d'alimentation et ceux des connecteurs du châssis de la voiture peuvent être différents en couleur.

- 1 Connectez les fils de couleur du cordon d'alimentation à la batterie de la voiture, aux enceintes et à l'antenne automatique (s'il y en a une) dans l'ordre suivant.

- ① Noir: à la masse
- ② Jaune: à la batterie de la voiture (12 V constant)
- ③ Rouge: à une borne accessoire
- ④ Bleu avec bande blanche: au fil de télécommande de l'autre appareil ou à l'antenne automatique s'il y en a une (200 mA max.)
- ⑤ Marron: à un système de téléphone cellulaire (Pour les détails, se référer aux instructions du téléphone cellulaire.)
- ⑥ Autres: aux enceintes

- 2 Connectez le cordon d'antenne.

- 3 Finalement, connectez le faisceau de fils à l'appareil.

**Remarque:** Si votre véhicule ne possède pas de borne accessoire, déplacez le fusible de la position de fusible 1 (position originale) à la position de fusible 2 et connectez le fil rouge (A7) à la borne positive (+) de la batterie.

- Le fil jaune (A4) n'est pas utilisé dans ce cas.

**Alvorens te verbinden:** Controleer de bedrading in de auto zorgvuldig. Het apparaat kan door verkeerde verbinding ernstige schade oplopen. De draden van het stroomkabel verschillen mogelijk van kleur met de aansluitingen op het chassis van de auto.

- 1 Sluit de gekleurde snoerdraden van de stroomkabel in de hierna genoemde volgorde aan op de accu van de auto, de luidsprekers en de antenne (indien aanwezig).

- ① Zwart: aarde
- ② Geel: naar de accu van de auto (constant 12 V)
- ③ Rood: naar de aansluitklem van de accessoire
- ④ Blauw met witte streep: naar afstandsbedieningsdraad van andere apparatuur of antenne met circuit indien aanwezig (200 mA max.)
- ⑤ Bruin: naar het mobiele-telefoonstelsysteem (Lees voor meer informatie de instructies die bij de mobiele telefoon worden geleverd.)
- ⑥ Andere: naar de speakers

- 2 Sluit de antenne aan.

- 3 Verbind de draadbundel daarna met het apparaat.

**Opmerking:** Als uw voertuig niet beschikt over een aansluitklem, moet u de zekering verplaatsen van stand 1 (beginstand) naar stand 2 en moet u de rode draad (A7) met de pluspool (+) van de accu verbinden.

- In dit geval wordt de gele draad (A4) niet gebruikt.

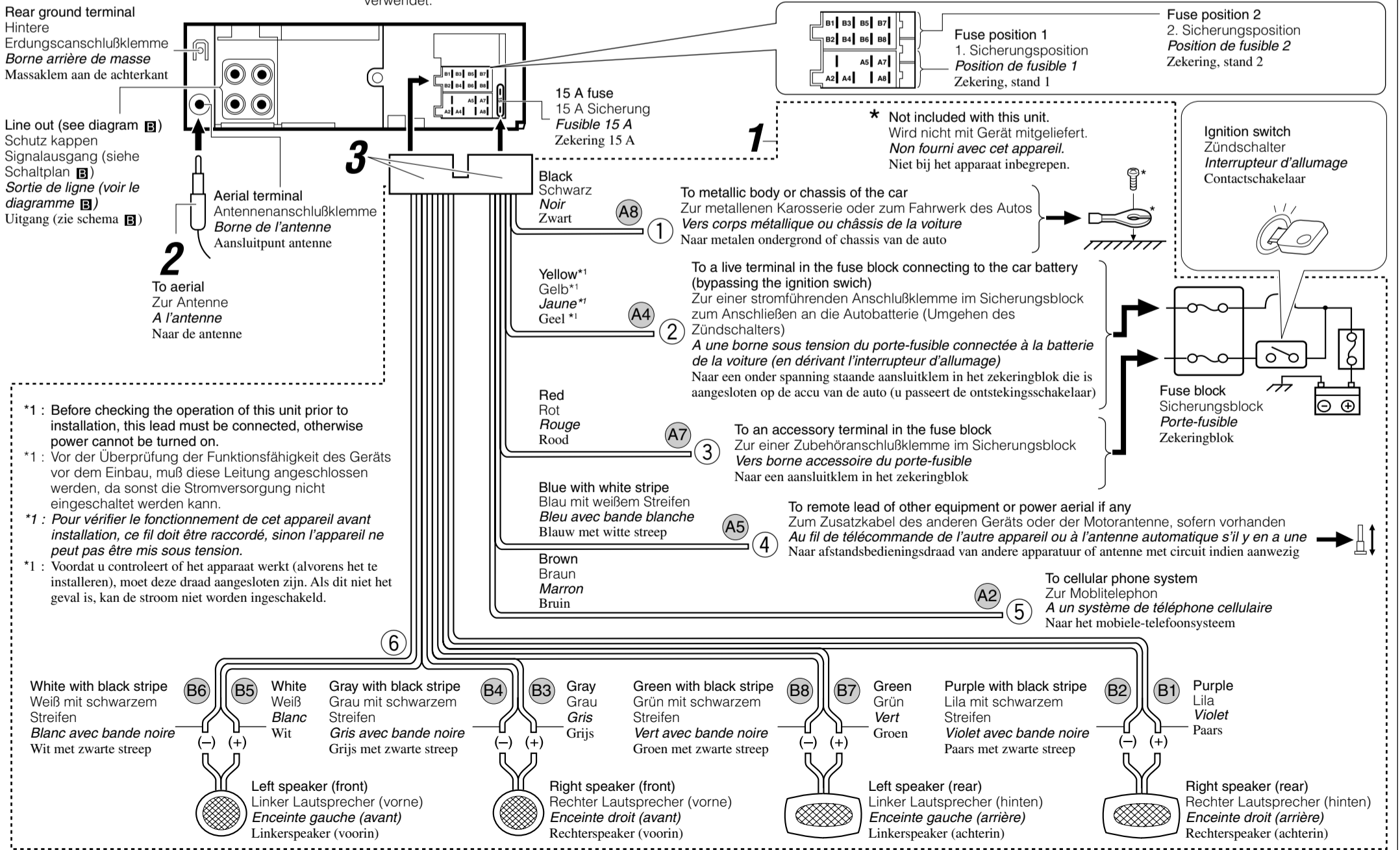

### PRECAUTIONS on power supply and speaker connections:

- **DO NOT** connect the speaker leads of the power cord to the car battery; otherwise, the unit will be seriously damaged.
- Connect the black lead (ground), yellow lead (to car battery, constant 12 V), and red lead (to an accessory terminal) correctly.
- **BEFORE** connecting the speaker leads of the power cord to the speakers, check the speaker wiring in your car.
  - If the speaker wiring in your car is as illustrated in Fig. 1 and Fig. 2 below, **DO NOT** connect the unit using that original speaker wiring. If you do, the unit will be seriously damaged. Redo the speaker wiring so that you can connect the unit to the speakers as illustrated in Fig. 3.
  - If the speaker wiring in your car is as illustrated in Fig. 3, you can connect the unit using the original speaker wiring in your car.
  - If you are not sure of the speaker wiring of your car, consult your car dealer.

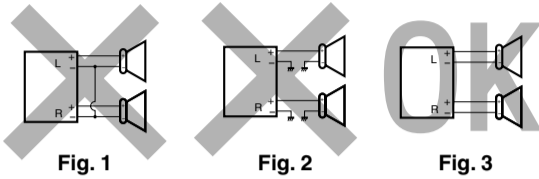

### VORSICHTSMASSREGELN beim Anschließen der Stromversorgung und Lautsprecher:

- Die Lautsprecherleitungen des Netzkabels **NICHT** an der Autobatterie anschließen, da sonst das Gerät schwer beschädigt wird.
- Die schwarze Leitung (Erdung), die gelbe Leitung (zur Autobatterie, konstant 12 V) und die rote Leitung (zur Zubehörschlußklemme) richtig anschließen.
- **VOR** dem Anschließen der Lautsprecherleitungen des Spannungsversorgungskabels an die Lautsprecher, die Lautsprecherverdrahtung in Ihrem Auto überprüfen.
  - Ist die Lautsprecherverdrahtung wie unten in „Fig. 1“ und „Fig. 2“ abgebildet, das Gerät **NICHT** mit der Originalverdrahtung der Lautsprecher anschließen, da sonst das Gerät schwer beschädigt wird. Die Lautsprecherverdrahtung erneuern, so daß Sie das Gerät an den Lautsprechern wie in „Fig. 3“ abgebildet anschließen können.
  - Ist die Lautsprecherverdrahtung in Ihrem Auto wie in „Fig. 3“ abgebildet, können Sie das Gerät mit der Originalverdrahtung der Lautsprecher in Ihrem Auto anschließen.
  - Sind Sie sich über die Lautsprecherverdrahtung in Ihrem Auto nicht sicher, wenden Sie sich an Ihren Autohändler.

### PRECAUTIONS sur l'alimentation et la connexion des enceintes:

- **NE CONNECTEZ PAS** les fils d'enceintes du cordon d'alimentation à la batterie; sinon, l'appareil serait sérieusement endommagé.
- Connectez correctement le fil noir (à la masse), le fil jaune (à la batterie de la voiture, 12 V constant) et le fil rouge (à la prise accessoire).
- **AVANT** de connecter les fils d'enceintes du cordon d'alimentation aux enceintes, vérifiez le câblage des enceintes de votre voiture.
  - Si le câblage des enceintes de votre voiture est comme montré sur la Fig. 1 ou Fig. 2 ci-dessous, **NE CONNECTEZ PAS** l'appareil en utilisant ce câblage original des enceintes. Si vous le faites, l'appareil sera sérieusement endommagé. Recommencez le câblage des enceintes de façon que vous puissiez connecter l'appareil aux enceintes comme montré sur la Fig. 3.
  - Si le câblage des enceintes de votre voiture est comme montré sur la Fig. 3, vous pouvez connecter l'appareil en utilisant ce câblage original d'enceintes pour votre voiture.
  - Si vous n'êtes pas sûrs du câblage d'enceintes de votre voiture, consultez le concessionnaire de votre voiture.

### VOORZORGSMAATREGELEN bij het verbinden van de stroomkabeldraad met de speakers:

- Verbind de speakerdraden van de stroomkabel **NIET** met de accu van de auto; als u dit wel doet, zal het apparaat ernstige schade oplopen.
- Sluit de zwarte draad (aarde), de gele draad (naar de accu van de auto, constant 12 V) en de rode draad (naar de aansluitklem van de accessoire) op de juiste wijze aan.
- **VOORDAT** u de speakerdraden van de stroomkabel met de speakers verbindt, moet u de bedrading van de speakers in uw auto controleren.
  - Als de bedrading van de speakers eruitziet zoals hieronder staat afgebeeld in Fig. 1 en Fig. 2, mag het apparaat **NIET** worden aangesloten met behulp van deze oorspronkelijke speakerbedrading. Als u dat wel doet, zal het apparaat ernstige schade oplopen. Pas de bedrading van de speakers aan, zodat u het apparaat met de speakers kunt verbinden, zoals staat afgebeeld in Fig. 3.
  - Als de bedrading van de speakers eruitziet zoals staat afgebeeld in Fig. 3, kunt u het apparaat aansluiten met behulp van de oorspronkelijke speakerbedrading in uw auto.
  - Als u twijfels hebt over de speakerbedrading in uw auto, moet u contact opnemen met uw autodealer.

### Connecting the leads / Anschließen der Leitungen / Raccordement des fils / Aansluiting van de gekleurde draden

Twist the core wires when connecting.  
Die Kerndrähte beim Anschließen verdrehen.  
*Torsader les âmes des fils en les raccordant.*  
Draai de kerndraden om elkaar heen wanneer u ze wilt aansluiten.

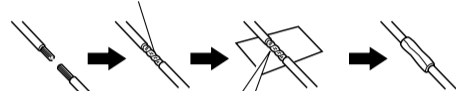

Solder the core wires to connect them securely.  
Die Kerndrähte anlöten, um sie fest anzuschließen.  
*Souder les âmes des fils pour les raccorder entre eux de façon sûre.*  
Soldeer de kerndraden zodat ze stevig vast zitten.

#### CAUTION / VORSICHT / PRECAUTION / LET OP!:

- To prevent short-circuit, cover the terminals of the **UNUSED** leads with insulating tape.
- Zur Vermeidung eines Kurzschlusses die Anschlußklemmen der **NICHT VERWENDETEN** Leitungen mit Isolierklebeband umwickeln.
- *Pour éviter les court-circuits, couvrir les bornes des fils qui ne sont PAS UTILISÉS avec de la bande isolante.*
- Om kortsluiting te voorkomen, moet u de aansluitklemmen van **ONGEBRUIKTE** gekleurde draden met isolatieband bedekken.

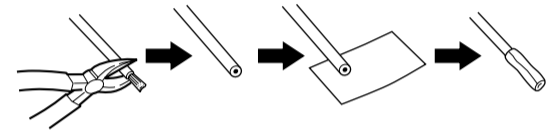

### Connections Adding Other Equipment / Anschlüsse zum Hinzufügen von anderer Ausrüstung / Raccordement pour ajouter d'autres appareils / Aansluitingen voor het toevoegen van andere apparatuur

You can connect an amplifier and other equipment to upgrade your car stereo system.

- Connect the remote lead (blue with white stripe) to the remote lead of the other equipment so that it can be controlled through this unit.
- Connect this unit's line-out terminals to the amplifier's line-in terminals.
- **Disconnect the speakers from this unit, connect them to the amplifier. Leave the speaker leads of this unit unused. (Cover the terminals of these unused leads with insulating tape, as illustrated above.)**

Sie können einen Verstärker oder ein anderes Gerät anschließen, um Ihre Autostereoanlage zu erweitern.

- Schließen Sie das Fernbedienungskabel (blau mit weißem Streifen) an das Fernbedienungskabel des anderen Geräts an, so daß es über dieses Gerät gesteuert werden kann.
- Die Anschlußklemmen am Ausgang dieses Gerät an den Anschlußklemmen des Eingangs des Verstärkers anschließen.
- Die Lautsprecher von diesem Gerät abtrennen und am Verstärker anschließen. Die Lautsprecherleitungen dieses Geräts unbenutzt lassen. (Die Anschlußklemmen dieser nicht verwendeten Leitungen mit Isolierklebeband umwickeln, siehe Abbildung oben.)

Vous pouvez connecter un amplificateur ou autre appareil pour améliorer votre système autoradio.

- Connectez le fil de commande à distance (bleu avec bande blanche) au fil de commande à distance de l'autre appareil de façon qu'il puisse être commandé via cet appareil.
- Raccorder les bornes de sortie ligne de cet appareil aux bornes d'entrée ligne de l'amplificateur.
- Déconnectez les enceintes de cet appareil et connectez-les à l'amplificateur. Laissez les fils d'enceintes de cet appareil inutilisés. (Recouvrir les extrémités de ces fils inutilisés avec de la bande isolante comme montré ci-dessus.)

Het is mogelijk om uw autostereosysteem uit te breiden met een versterker of andere apparatuur.

- Verbind de afstandsbedieningsdraad (blauw met witte streep) met de afstandsbedieningsdraad van andere apparatuur zodat deze op afstand via dit apparaat kan worden bediend.
- Verbind de uitgang van het apparaat met de ingang van de versterker.
- **Koppel de speakers van dit apparaat los en verbind ze aan de versterker. Gebruik de speakerdraden van dit apparaat niet. (Plak de aansluitklemmen van deze speakerdraden met isolatieband af zoals hierboven is afgebeeld.)**

### Amplifier / Verstärker / Amplificateur / Versterker

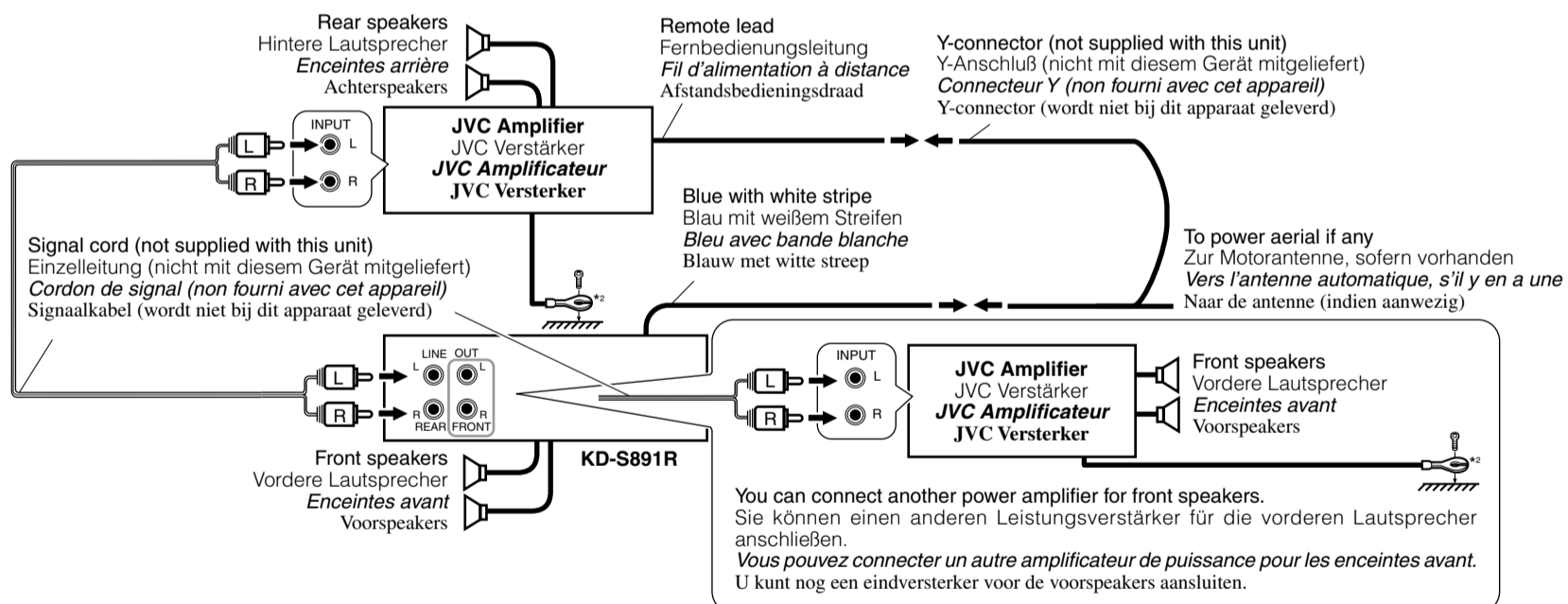

\*2 : Firmly attach the ground wire to the metallic body or to the chassis of the car—to the place not coated with paint (if coated with paint, remove the paint before attaching the wire). Failure to do so may cause damage to the unit.

\*2 : Verbinden Sie den Erdungsleiter mit der Karosserie oder dem Rahmen des Fahrzeugs. Die Kontaktstelle darf nicht lackiert sein (sollte die Kontaktstelle lackiert sein, entfernen Sie den Lack der Kontaktstelle, bevor Sie den Leiter befestigen). Wenn der Erdungsleiter nicht ordnungsgemäß angeschlossen wird, kann dieses Gerät beschädigt werden.

\*2 : Attachez solidement le fil de mise à la masse au châssis métallique de la voiture—à un endroit qui n'est pas recouvert de peinture (s'il est recouvert de peinture, enlevez d'abord la peinture avant d'attacher le fil). L'appareil peut être endommagé si cela n'est pas fait correctement.

\*2 : Bevestig de aarddraad goed met een metalen onderdeel of het chassis van de auto—bevestig op een niet-gelakt gedeelte (indien gelakt, schuur dan af alvorens de draad te bevestigen). Het toestel kan worden beschadigd indien de aarddraad niet goed is aangesloten.

### TROUBLESHOOTING

- **The fuse blows.**
  - \* Are the red and black leads connected correctly?
- **Power cannot be turned on.**
  - \* Is the yellow lead connected?
- **No sound from the speakers.**
  - \* Is the speaker output lead short-circuited?
- **Sound is distorted.**
  - \* Is the speaker output lead grounded?
  - \* Are the “-” terminals of L and R speakers grounded in common?
- **Unit becomes hot.**
  - \* Is the speaker output lead grounded?
  - \* Are the “-” terminals of L and R speakers grounded in common?

### FEHLERSUCHE

- **Die Sicherung brennt durch.**
  - \* Sind die roten und schwarzen Leitungen richtig angeschlossen?
- **Stromversorgung kann nicht eingeschaltet werden.**
  - \* Ist die gelbe Leitung angeschlossen?
- **Kein Ton aus den Lautsprechern.**
  - \* Ist die Lautsprecherausgangsleitung kurzgeschlossen?
- **Ton verzerrt.**
  - \* Ist die Lautsprecherausgangsleitung geerdet?
  - \* Sind die (-) Anschlußklemmen der linken und rechten Lautsprecher zusammen geerdet?
- **Gerät wird heiß.**
  - \* Ist die Lautsprecherausgangsleitung geerdet?
  - \* Sind die (-) Anschlußklemmen der linken und rechten Lautsprecher zusammen geerdet?

### EN CAS DE DIFFICULTES

- **Le fusible saute.**
  - \* Les fils rouge et noir sont-ils raccordés correctement?
- **L'appareil ne peut pas être mise sous tension.**
  - \* Le fil jaune est-elle raccordée?
- **Pas de son des enceintes.**
  - \* Le fil de sortie d'enceinte est-il court-circuité?
- **Le son est déformé.**
  - \* Le fil de sortie d'enceinte est-il à la masse?
  - \* Les bornes “-” des enceintes gauche et droit sont-elles mises ensemble à la masse?
- **L'appareil devient chaud.**
  - \* Le fil de sortie d'enceinte est-il à la masse?
  - \* Les bornes “-” des enceintes gauche et droit sont-elles mises ensemble à la masse?

### PROBLEMEN OPLOSSEN

- **De zekering slaat door.**
  - \* Zijn de rode en de zwarte draden op de juiste manier aangesloten?
- **De stroom kan niet worden ingeschakeld.**
  - \* Is de gele draad aangesloten?
- **Er komt geen geluid uit de speakers.**
  - \* Is de uitgaande speakerdraad kortgesloten?
- **Het geluid wordt vervormd.**
  - \* Is de uitgaande speakerdraad geerd?
  - \* Zijn de “-” polen van de linker- en de rechterspeakers gemeenschappelijk geerd?
- **Het apparaat raakt verhit.**
  - \* Is de uitgaande speakerdraad geerd?
  - \* Zijn de “-” polen van de linker- en de rechterspeakers gemeenschappelijk geerd?